

Shed light on complexity



Walraven Solar Panel Fixing Solutions

Easy modular fixing solutions for your demanding and complex solar panel installation projects

Inspired by smart solutions from the start

Walraven is your solution partner in the global installation market. As a family-owned business founded in 1942, long-term thinking comes naturally to us. We truly believe we can make a sustainable difference by building a *multinational with a heart*. We connect with you and the market to understand your needs, and bring in our simple and smart fixing solutions. We share our know-how, and provide our services - everything you need **to make your work easier, more effective, safer and more sustainable.**

Walraven. The value of smart

Walraven Solar Panel Fixing Solutions

Features & benefits

Complete, modular systems

Walraven Solar Panel Fixing Systems offers versatile, modular solutions that make your installation of solar panels easy, safe and efficient. Walraven is there for you in every stage of your solar panel installation project, no matter how complicated.

Personal, technical service and support

In addition to our versatile solutions, we offer you our technical expertise and personal support through all the phases of your project. From the early stage with calculations and technical drawings, to on-site support and the system's installation.

Basic to highly complex installations

We are your partner, not only in basic installations but especially in complex ones like installations on high roofs, roofs with a complex layout, and with high wind loads.



Case Study

The installation of 219 solar panels
on a rooftop of 1585 m²

1585 m² of rooftop needed to be dressed up
with 219 solar panels without moving the installed
machine and perforating the roof. Does it seem
complex, almost impossible? But our Spanish
colleagues make it look easy with our modular
fixing solution!

Laboratory roof, Kymos Spain



Requirements

- The installation of solar panels without moving or touching the installed machines like the climate control machines and air handling units.
- Avoid perforation of the rooftop.



Solution

For the installation of the solar panels, 2.5 m above the roof, Walraven designed and supplied a solar panel support system including the following components:

- Walraven Maxx Heavy Rail Profile
- Walraven RapidStrut® Fixing Rail (Walraven BIS UltraProtect® 1000)
- Walraven Maxx Linear Connector
- Walraven Maxx Base Plate
- Walraven Maxx Profile Connector 90°
- Walraven Solar Panel Clamps

By placing ballast blocks, we could add the needed extra load without perforating the rooftop. The solar panels have a >2% slope for water drainage and minimal shade effect.



Project highlights

- Optimal use of space by placing the solar panels above the existing equipment.
- Maximising the yield of the panels by the low slope.
- Reduced heat impact on the HVAC equipment and roof.
- Installed without interruption of the operation of the building.
- No welding necessary.



Walraven Solar Panel Fixing Solutions

Modular fixing systems

Walraven offers a wide range of fixing solutions for photovoltaic and solar thermal panels encountering all the different scenarios you may face during your installation.

Walraven RapidStrut® Fixing Rails

The essential basis for all solar panel fixing constructions:

- For all medium rail applications
- Easy, quick, and safe to install
- Compatible with Walraven Maxx Heavy Rail System
- Including personal, excellent service & support

Walraven RapidStrut® Accessories

A seamless connection with our versatile solar panel fixing accessories:

- Easy, quick, and safe to install
- Pre-assembled and delivered 'ready-to-use' to the building site
- Compatible with Walraven Maxx Heavy Rail System
- Including personal, excellent service & support

Walraven Yeti® Roof Support System

Walraven Yeti® Roof Support System is perfect for solar installations on pitched and flat rooftops, flat grounds, and other flat surfaces, for example, in field locations. Our unique Roof Support Systems give the advantage that roof perforations are not always necessary.

Walraven BIS UltraProtect® 1000

Walraven BIS UltraProtect® 1000 is a surface protection suitable for indoor and outdoor use. It is unique in scope, composition, and corrosion resistance, making it the most sustainable solution for fixing or supporting mechanical installations, solar systems, and other types of installations.



Walraven RapidStrut®

For all medium weight applications

Walraven RapidStrut® is our complete rail system supporting medium loads for versatile indoor and outdoor use.

It seamlessly integrates with an extensive choice of pre-assembled accessories that enable you to save installation time.



Walraven RapidStrut® Fixing Rail (Walraven BIS UltraProtect® 1000)

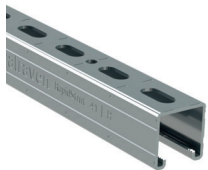

	L 21 M	21 H*	41 L	41 M*	41 H*	51 M	62 H	82 H
(m)	41 x 21 x 2.0 mm	41 x 21 x 2.5 mm	41 x 41 x 1.5 mm	41 x 41 x 2.0 mm	41 x 41 x 2.5 mm	41 x 51 x 2.0 mm	41 x 62 x 2.5 mm	41 x 82 x 2.5 mm
2	-	65018227	-	65018242	65018247	65058252	-	-
3	-	65018327	65018344	65018342	65018347	65058352	65018367	65018387
6	65018622	65018627	65018644	65018642	65018647	65058652	65018667	65018687



Fire certified
41-H, 62-H, 82-H



RAL-GZ 655/C
Cert.Nr. 2015-02

Walraven PV Clamp



7904150



79040XX

Features and benefits

- For fixing photovoltaic solar panels to Walraven RapidStrut® profiles
- Material: steel
- Surface protection: dacromet

Part No.	Model	Solar panel thickness (mm)
7904150	Middle clamp for Strut	35 - 50
7904030	End clamp for Strut	30
7904035	End clamp for Strut	35
7904040	End clamp for Strut	40
7904045	End clamp for Strut	45
7904050	End clamp for Strut	50

Walraven RapidStrut® G2 Accessories

Installation - insert, lock, done!



Features and benefits

- Quick and easy fixing to the rail
- Pre-assembled 'ready-to-use'
- Suitable for all Strut profiles
- Saves up to 40% fixing time!
- Optimised for easy installation with electrical tools
- Walraven BIS UltraProtect® 1000 protection for indoor and outdoor use

Walraven RapidStrut® Hammerfix G2

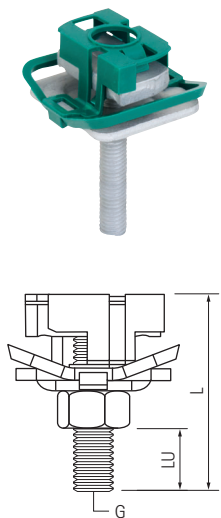

Part No.	G	L (mm)	LU (mm)
652785804	M8	40	16
652785805	M8	50	26
652785806	M8	60	36
652785808	M8	80	56
652785810	M8	100	76
652785004	M10	40	12
652785006	M10	60	32
652785008	M10	80	52
652785010	M10	100	72
652785204	M12	40	10
652785206	M12	60	30



Walraven RapidStrut® Hammerfix 'U' G2

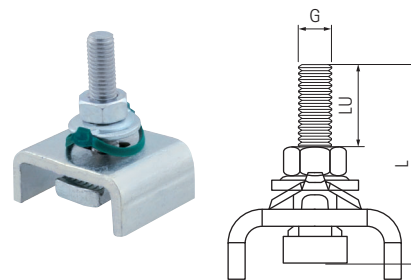

Part No.	Type	L (mm)	LU (mm)
665285006	M10	60	30



Walraven RapidStrut® Slide Nut G2



Part No.	Type
665185106	M6
665185108	M8
665185110	M10
665185112	M12



Walraven RapidStrut® Slide Nuts Plastic Tab

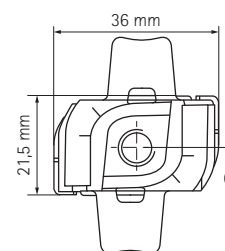

Part No.	G
651868008	M8
651868010	M10
651868012	M12



**Walraven RapidStrut®
Rail Connector G2**

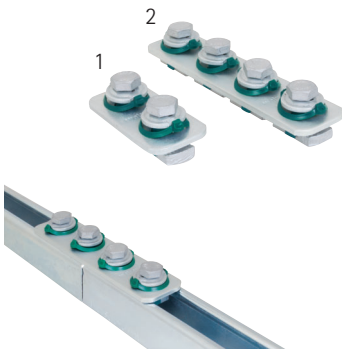

Part No.	
1	665885184
2	665885186



**Walraven RapidStrut®
Rail Connector (U-shaped) G2**

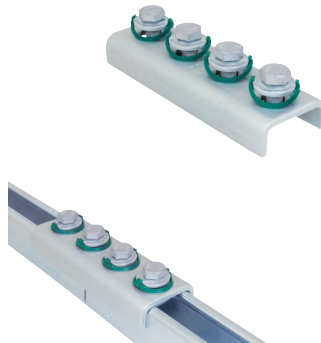

Part No.	
665885421	



**Walraven RapidStrut®
Rail Connector 90° G2**

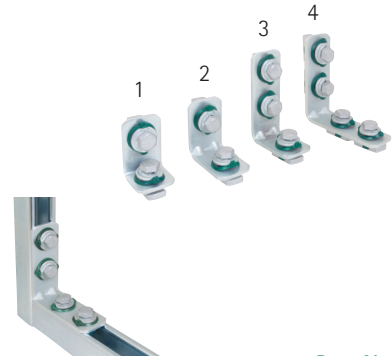

Part No.	
1	665885102
2	665885202
3	665885203
4	665885205



Walraven RapidStrut® Rail T- and X-Connector G2

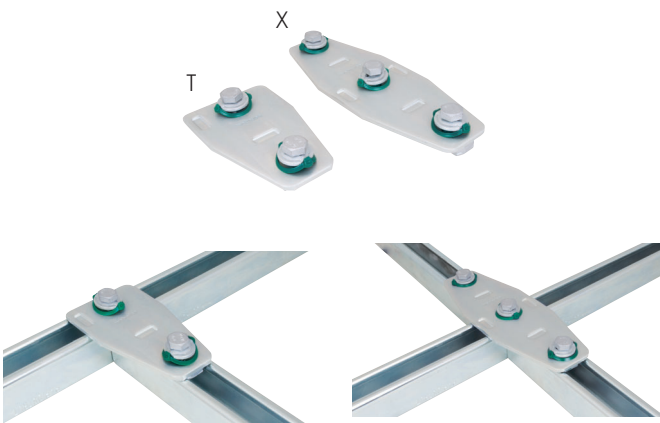

Part No.	Type
665885213	T
665885223	X



Walraven RapidStrut® Cross Connector G2

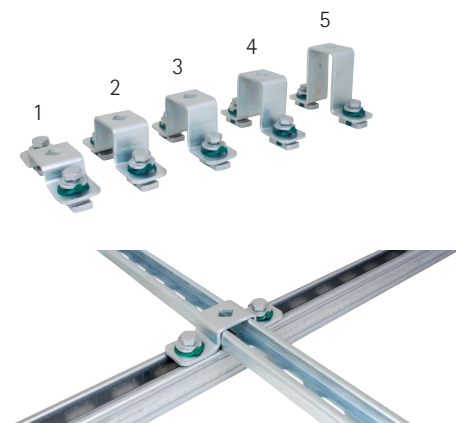

Part No.	For
1	665885402 Strut 41 x 21
2	665885404 Strut 41 x 41
3	665885405 Strut 41 x 51
4	665885406 Strut 41 x 62
5	665885408 Strut 41 x 82



Walraven RapidStrut® Accessories

For rail construction and finishing

Walraven RapidStrut® Rail End Cap



Part No.	For
6566021	Strut 41 x 21
6566041	Strut 41 x 41
6566051	Strut 41 x 51
6566062	Strut 41 x 62
6566082	Strut 41 x 82

Material: PE (polyethylene), green

Walraven starQuick® Universal Rail Adaptor

Adaptor for fixing Walraven starQuick® Clamps to Walraven RapidRail® or Strut Rail. To add pipework quickly and simply to an existing installation. Suitable for Walraven starQuick® Clamps 10 to 55 mm. Suitable for Walraven RapidRail® 27 x 18 mm, 30 x 15 mm, 30 x 20 mm, 30 x 30 mm, 30 x 45 mm, 38 x 40 mm + Strut.

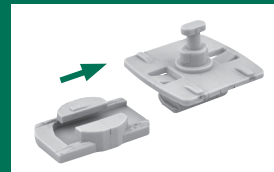

Walraven RapidStrut® PVC Profile

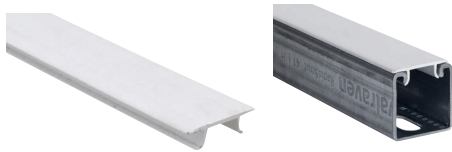

Part No.	L
6566999	3 m

Material: PVC (polyvinylchloride), white

Walraven RapidStrut® Rubber Strip

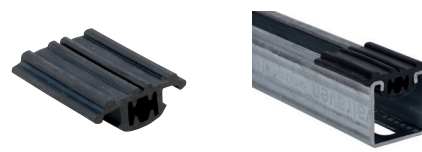

Part No.	L
6568041	30 m
6568042	50 m

Material: EPDM rubber, black



Walraven Yeti® Roof Support System

A solid and reliable foundation for any Strut based installation

Walraven Yeti® 480



Walraven Yeti® 480 is a non-penetrative, modular system for supporting installations on flat roofs, other flat surfaces and even on low pitched roofs (up to 7°). The sturdy Walraven Yeti® feet are used in combination with Walraven RapidStrut® fixing rail. With the optional ballast blocks extra weight can be added providing even greater stability. The Walraven Yeti® 480, available for both vertical and horizontal applications, is equipped with a non-slip, anti-vibration mat which prevents damage to the roof membrane, thereby minimising the risk of leakage.

Walraven Yeti® 335



The Walraven Yeti® 335 is the smaller family member of the Walraven Yeti® 480. It is designed to support installations on flat roofs or other flat surfaces, in combination with Walraven RapidStrut® fixing rail. The Walraven Yeti® 335, available for both vertical and horizontal applications, is supplied with a 360° rotatable insert, allowing precise positioning. It also comes with a non-slip, anti-vibration mat to prevent damage to the roof membrane.

Walraven Yeti® 130

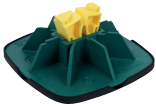

A flexible and reliable foundation for light Strut based installations on roofs. It also comes with a non-slip, anti-vibration mat to prevent damage to the roof membrane.

Walraven Ursus Foot



Walraven Ursus is designed to support small, linear pipework systems, ductwork runs, cable trays and is ideal for climate installations, walkways and similar on flat roofs. The Walraven Ursus Foot Support System is made from UV resistant, vulcanised rubber, and includes a Walraven RapidStrut® fixing rail piece, with Walraven BIS UltraProtect® 1000 surface protection.

Features and benefits



No drilling required

Prevents penetration of roof membrane and reduces the risk of leaks.



Recycled materials

Mounting units are made from recycled weather and UV resistant materials.



Optimized load distribution

Optimal distribution of the load and reduction of dead weight protects the roof surface.



Saves time and money

Easy to use modular support system.



Sound & vibration proof

With non-slip anti-vibration mat.



SG Bauakustik

Nr. 1762-001-18

Walraven BIS UltraProtect® 1000

In order to protect your installations against harsh conditions, a durable surface protection is needed. Hot Dip Galvanising is often used, but not always the most **sustainable** option.

Our unique Walraven BIS UltraProtect® 1000 is our answer to a more durable, more sustainable, smoother and more versatile **surface protection** that combines easily with other products.



Sustainable alternative

Walraven BIS UltraProtect® 1000 is the sustainable alternative to the traditional hot dip galvanisation process.

- Seven times less energy use
- No use of tap water
- Own water cleaning system
- Emission of cleaned air
- Up to 55% resources savings compared to hot dip galvanised

Smooth and versatile

Products feel smooth and are visually appealing. Moreover, the applications are versatile.

- Also suitable for threaded products
- It perfectly matches with products in the Walraven BIS UltraProtect® 1000 system
- Also combines with zinc plated pre-galvanised or hot dip galvanised products

** Until the occurrence of maximum 5% red rust and with a layer thickness of 50 - 80 µm.*

Optimal durability

Proven to be suitable for corrosive environments.

- Corrosion resistance class C1-C4 in accordance with ISO 12944-2
- Effortlessly withstands a salt spray test of at least 1000 hours in line with ISO 9227 *

Salt spray test

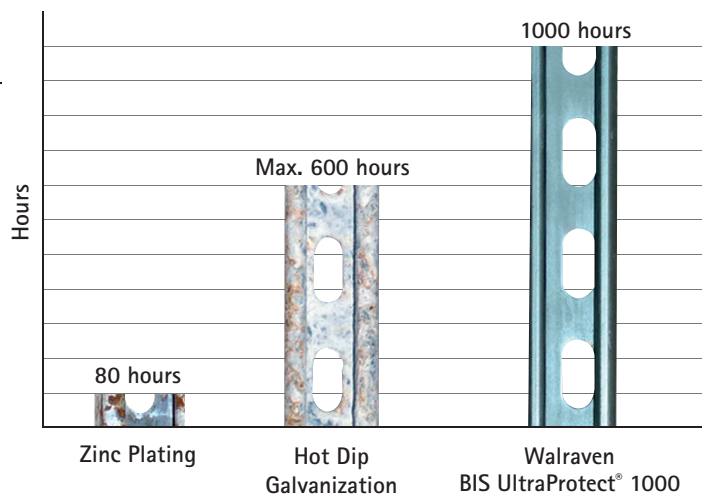

Additional service & support

From engineering to on-site construction support

When preparing or executing a solar-related project, you may encounter challenges that you can't solve yourself. That's where Walraven comes in with up-to-date local knowledge and expertise.

At Walraven, the service continues after you have purchased our products. We offer support and technical advice through all the phases of your projects. Based on your requirements, our Technical Engineers deliver you a comprehensive proposal, including detailed load and wind calculations, AutoCAD drawings and parts lists. All to make your life a little easier.

Contact our technical team: export@walraven.com

The Walraven specialists are always ready to support!



Examples

Pitched roofs

Fixing solutions for different types of pitched roofs.



Flat roofs

Different solutions and orientations for flat roofs.

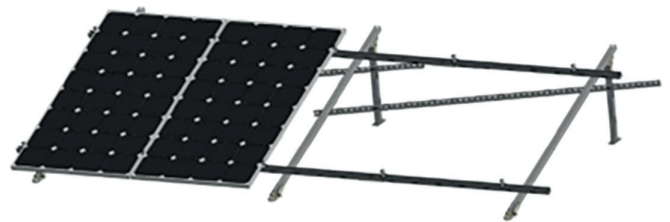

Land

Fixing solutions for large and medium size open land.

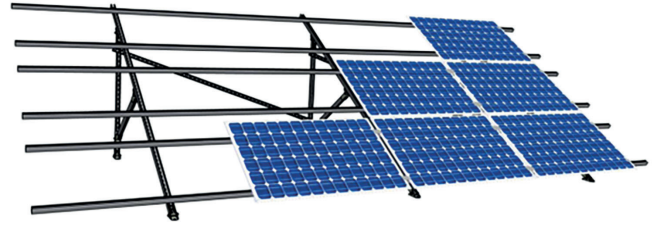

Complex roofs

Different fixing solutions for complex roofs with HVAC units, sky lights etc.

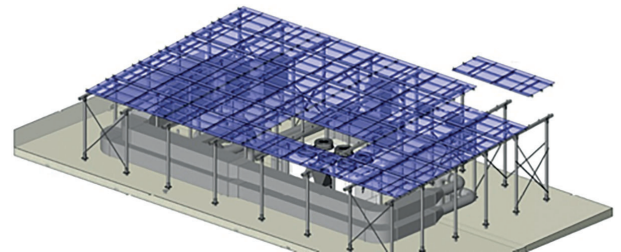

Find out how we can support you

Would you like to find out more about the solutions described in this brochure?

Or would you like to discuss how we could help you find the best possible solution for your project?

Get in touch with us today!

Walraven International

Industrieweg 5
3641 RK Mijdrecht (NL)
Tel. +31 297 23 30 00
Fax +31 297 23 30 99
export@walraven.com

Walraven Group

Mijdrecht (NL) · Tienen (BE) · Bayreuth (DE) · Banbury (GB) · Malmö (SE) · Grenoble (FR) · Barcelona (ES) · Milan (IT)
Kraków (PL) · Mladá Boleslav (CZ) · Kyiv (UA) · Danville (US) · Shanghai (CN) · Dubai (AE) · Budapest (HU) · Mumbai (IN)
Singapore (SG) · Burlington (CA) · Athens (GR)