

Increase your
installation efficiency

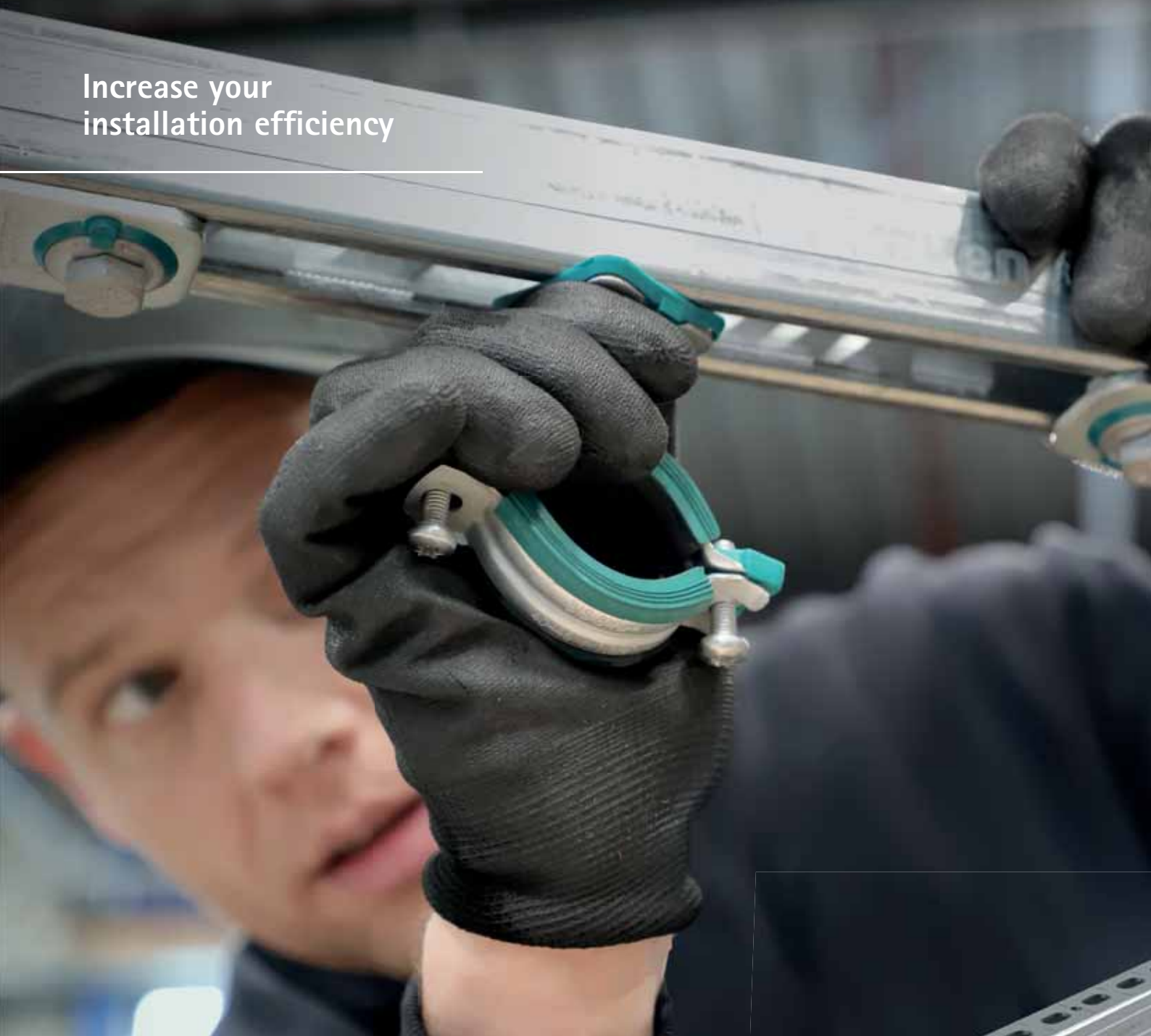

Walraven RapidStrut®

A complete rail system for versatile
medium weight applications



Walraven RapidStrut®

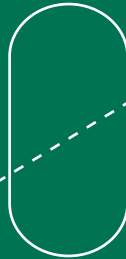

+ A sustainable solution for all medium weight applications

+ Complete range of accessories

+ Fast and easy fixing

+ For indoor and outdoor use

Inspired by smart solutions from the start

Walraven is a globally active company in the installation industry, founded in 1942. We have always been dedicated to make the work of our customers easier and more effective. With simple and smart solutions, comprehensive services and excellent support.

Walraven. The value of smart

Walraven RapidStrut®

For all medium weight applications

Walraven RapidStrut® is our complete rail system supporting medium loads for versatile indoor and outdoor use.

It seamlessly integrates with an extensive choice of pre-assembled accessories that enable you to save installation time.

Also available with the more sustainable and high performance Walraven BIS UltraProtect® 1000 surface protection.





Walraven RapidStrut®

Features & benefits

Easy, quick & safe to install

- The accessories of Walraven RapidStrut® are pre-assembled and delivered ready to use on-site.
- The plastic spring of the fixing system allows the slide nut to be fixed easily into the rail, retaining the assembly in place before final tightening.
- Easy to connect to walls and ceilings by using concrete screws Walraven W-LX-P in the special 8.5 mm anchor holes of the rails.
- In combination with the Walraven DS 5, the Walraven RapidStrut® profile allows quick fixings to be mounted on both sides of the rail.

Extensive, high-quality range

- The Walraven RapidStrut® fixing system offers a versatile choice for rail profiles and cantilever arms, including a broad range of accessories.
- The strong teeth ensure strong and safe connections.
- Minimal trumpet effect after cutting due to the gentle roll-forming process on our machinery. This also ensures easy installation of the accessories.
- Traceability coding ensures quality management.

Sustainable for indoor and outdoor use

- Our experts have used the optimal amount of steel which results in a clean design and a sustainable rail system.
- Walraven RapidStrut® is highly corrosion resistant, and therefore also suitable for outdoor use.
- Available with Walraven BIS UltraProtect® 1000 - the high performance and sustainable surface protection. This technology uses 55% less resources compared to conventional hot dip galvanisation.



Additional service & support

Technical design support

- Our Technical Support Team helps you find the most effective solutions for your construction challenges. We can also provide you with CAD / BIM data where needed. For the best possible result, it is important to engage us as early as possible in your project.

Prefabrication service

- To save you even more time on-site, we offer a prefabrication service for larger installations.



Minimal trumpet effect after cutting

Walraven RapidStrut® Rails and Cantilever Arms

Walraven RapidStrut® Fixing Rails (Walraven BIS UltraProtect® 1000)



L (m)	21 M 41 x 21 x 2.0 mm	21 H* 41 x 21 x 2.5 mm	41 L 41 x 41 x 1.5 mm	41 M* 41 x 41 x 2.0 mm	41 H* 41 x 41 x 2.5 mm	51 M 41 x 51 x 2.0 mm	62 H 41 x 62 x 2.5 mm	82 H 41 x 82 x 2.5 mm
2	-	65018227	-	65018242	65018247	65058252	-	-
3	-	65018327	65018344	65018342	65018347	65058352	65018367	65018387
6	65018622	65018627	65018644	65018642	65018647	65058652	65018667	65018687

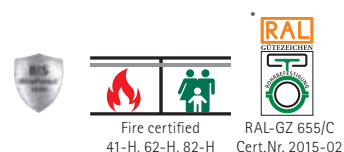

Walraven RapidStrut® Fixing Rails (pre-galvanized)



L (m)	21 L* 41 x 21 x 1.5 mm	21 M* 41 x 21 x 2.0 mm	21 H* 41 x 21 x 2.5 mm	41 L* 41 x 41 x 1.5 mm	41 M* 41 x 41 x 2.0 mm	41 H* 41 x 41 x 2.5 mm	62 H 41 x 62 x 2.5 mm	82 H 41 x 82 x 2.5 mm
2	6505224	6505222	6505225	6505244	6505242	6505245	-	-
3	6505324	6505322	6505325	6505344	6505342	6505345	6505365	6505385
6	6505624	6505622	6505625	6505644	6505642	6505645	6505665	6505685

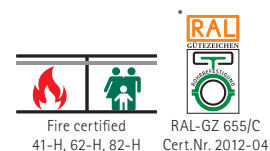

Walraven RapidStrut® Fixing Rail Double



L (m)	Surface protection	21 M Double	41 M Double	62 H Double
6	Pre-galvanized	65015626	65015646	65015666
6	Walraven BIS UltraProtect® 1000	65018626	65018646	65018666

Walraven RapidStrut® Base Plate



Part No.	Model	Surface protection
66583804	Standard	Zinc plated
665885400	Pre-assembled with fasteners	Walraven BIS UltraProtect® 1000

For Walraven RapidStrut® 21, 42, 51, 62, 82





Walraven RapidStrut® Cantilever Arms

L (mm)	21 M vertical 41 x 21 x 2.0 mm	21 H 41 x 21 x 2.5 mm	41 H with support 41 x 41 x 2.5 mm	41 M 41 x 41 x 2.0 mm	41 H 41 x 41 x 2.5 mm	41 M Double 41 x 41D x 2.0 mm
150	-	-	-	-	66084115	-
200	-	66082120	-	-	66084120	-
300	6603828	66082130	-	66084030	66084130	-
400	-	-	-	-	-	66088240
450	-	66082145	-	66084045	66084145	-
600	6603829	66082160	6601894	66084060	66084160	66088260
750	-	-	-	-	66084175	-
800	-	-	-	-	-	66088280
1000	-	-	-	-	66084198	66088298
1200	-	-	-	-	66084199	-



Walraven BIS UltraProtect® 1000

In order to protect your installations against harsh conditions, a durable surface protection is needed. Hot Dip Galvanising is often used, but not always the most **sustainable** option.

Our unique Walraven BIS UltraProtect® 1000 is our answer to a more durable, more sustainable, smoother and more versatile **surface protection** that combines easily with other products.



Sustainable alternative

Walraven BIS UltraProtect® 1000 is the sustainable alternative to the traditional hot dip galvanisation process.

- Seven times less energy use
- No use of tap water
- Own water cleaning system
- Emission of cleaned air
- Up to 55% resources savings

Smooth and versatile

Products feel smooth and are visually appealing. Moreover, the applications are versatile.

- Also suitable for threaded products
- It perfectly matches with products in the Walraven BIS UltraProtect® 1000 system
- Also combines with zinc plated pre-galvanised or hot dip galvanised products

* *Until the occurrence of maximum 5% red rust and with a layer thickness of 50 - 80 µm.*

Optimal durability

Proven to be suitable for corrosive environments.

- Corrosion resistance class C1-C4 in accordance with ISO 12944-2
- Effortlessly withstands a salt spray test of at least 1000 hours in line with ISO 9227 *

Salt spray test

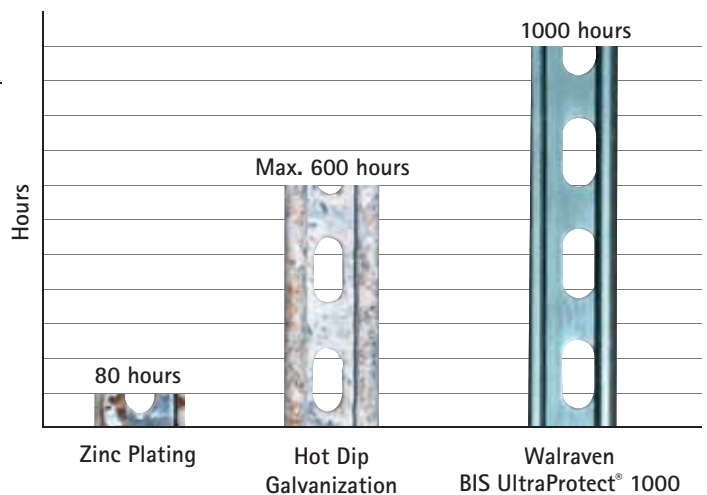

Walraven RapidStrut® system

A complete range of seamlessly integrated solutions

All our products are developed to combine effortlessly with Walraven accessories and our other products in order to build the perfect solution for your project.

- Walraven RapidStrut® G2 Accessories
- Walraven RapidStrut® Accessories
- Walraven PushStrut
- Other Walraven accessories and stainless steel
- Other Walraven fixing products

Walraven RapidStrut® G2 Accessories

For pipe fixing & rail construction

Installation – insert, lock, done!



Features and benefits

- Quick and easy fixing to the rail
- Pre-assembled 'ready-to-use'
- Suitable for all Strut profiles
- Saves up to 40% fixing time!
- Optimised for easy installation with electrical tools
- Walraven BIS UltraProtect® 1000 protection for indoor and outdoor use

Walraven RapidStrut® Hammerfix G2

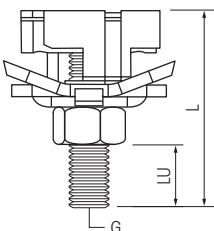

Part No.	G	L (mm)	LU (mm)
652785804	M8	40	16
652785805	M8	50	26
652785806	M8	60	36
652785808	M8	80	56
652785810	M8	100	76
652785004	M10	40	12
652785006	M10	60	32
652785008	M10	80	52
652785010	M10	100	72
652785204	M12	40	10
652785206	M12	60	30



Walraven RapidStrut® Slide Nuts G2



Part No.	Type
665185106	M6
665185108	M8
665185110	M10
665185112	M12



Walraven RapidStrut® Hammerfix 'U' G2

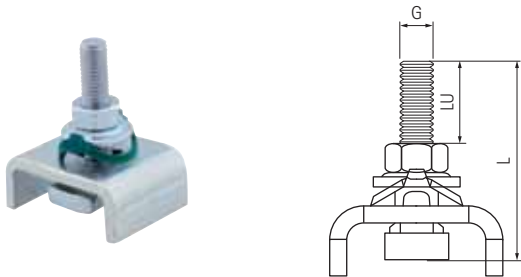

Part No.	Type	L (mm)	LU (mm)
665285006	M10	60	30



Walraven RapidStrut® Slide Nuts Plastic Tabs

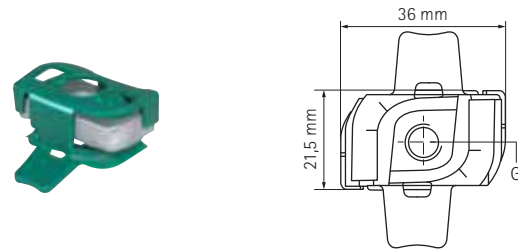

Part No.	G
651868008	M8
651868010	M10
651868012	M12



Walraven RapidStrut® Rail Connectors G2

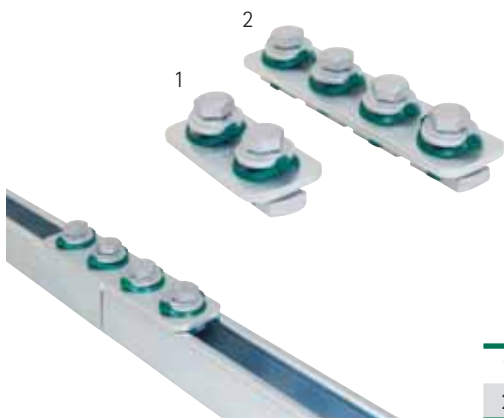

	Part No.
1	665885184
2	665885186



Walraven RapidStrut® Rail Connector (U-shaped) G2

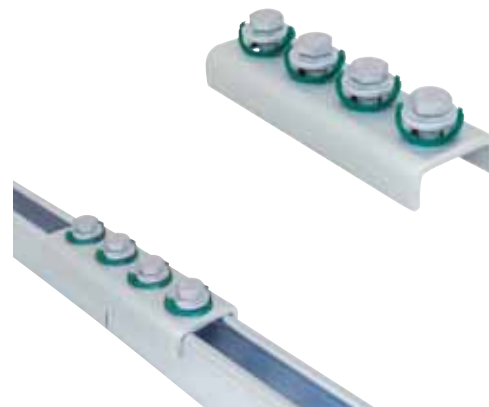

	Part No.
	665885421



Walraven RapidStrut® G2 Accessories

For pipe fixing & rail construction

Walraven RapidStrut® Rail T- and X-Connector G2

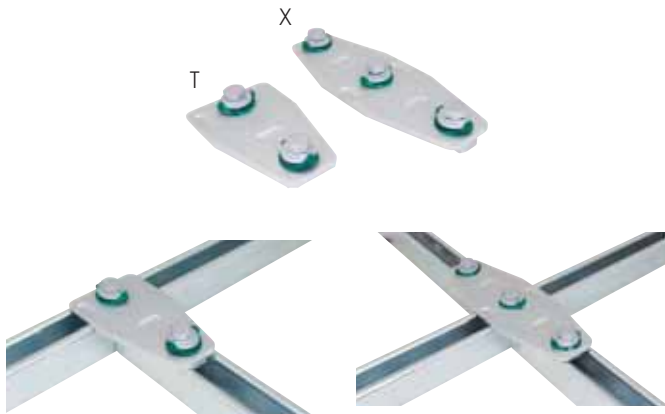

Part No.	Type
665885213	T
665885223	X



Walraven RapidStrut® Cross Connectors G2

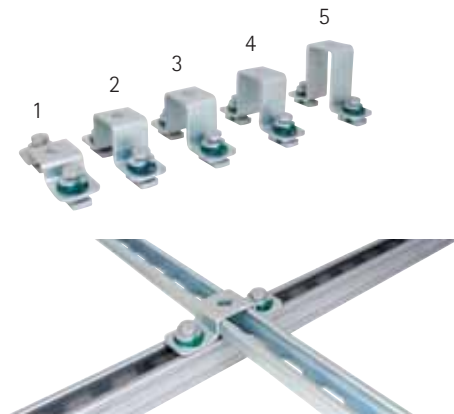

	Part No.	For
1	665885402	Strut 41 x 21
2	665885404	Strut 41 x 41
3	665885405	Strut 41 x 51
4	665885406	Strut 41 x 62
5	665885408	Strut 41 x 82



Walraven RapidStrut® Rail Connectors 90° G2

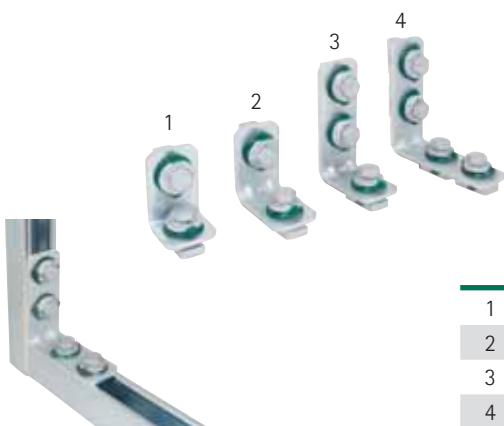

	Part No.
1	665885102
2	665885202
3	665885203
4	665885205



Walraven RapidStrut® Rail Connectors 135° G2

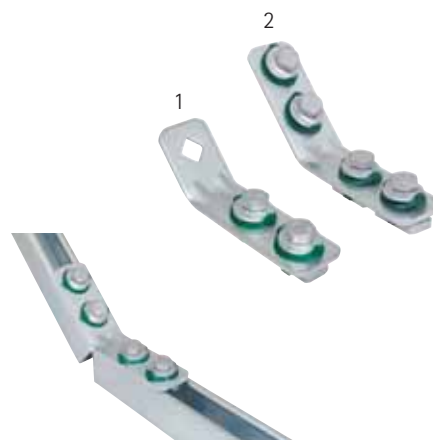

	Part No.
1	665885330
2	665885235



Walraven RapidStrut® Accessories

For rail construction and finishing

Walraven Rail Junction Angle Bracket



Part No.

65938020



Walraven Strut Angle Bracket



Part No.

66038020



Walraven Rail Prop



Part No.

66288530



Walraven RapidStrut® Rail End Caps

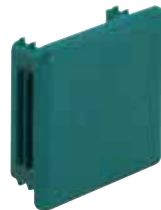

Part No.	For
6566021	Strut 41 x 21
6566041	Strut 41 x 41
6566051	Strut 41 x 51
6566062	Strut 41x 62
6566082	Strut 41x 82

Material: PE (polyethylene), green

Walraven RapidStrut® PVC Profile



Part No.

6566999

L

3 m

Material: PVC (polyvinylchloride), white

Walraven RapidStrut® Rubber Strips



Part No.

6568041

L

30 m

6568042

50 mm

Material: EPDM rubber, black

Walraven PushStrut

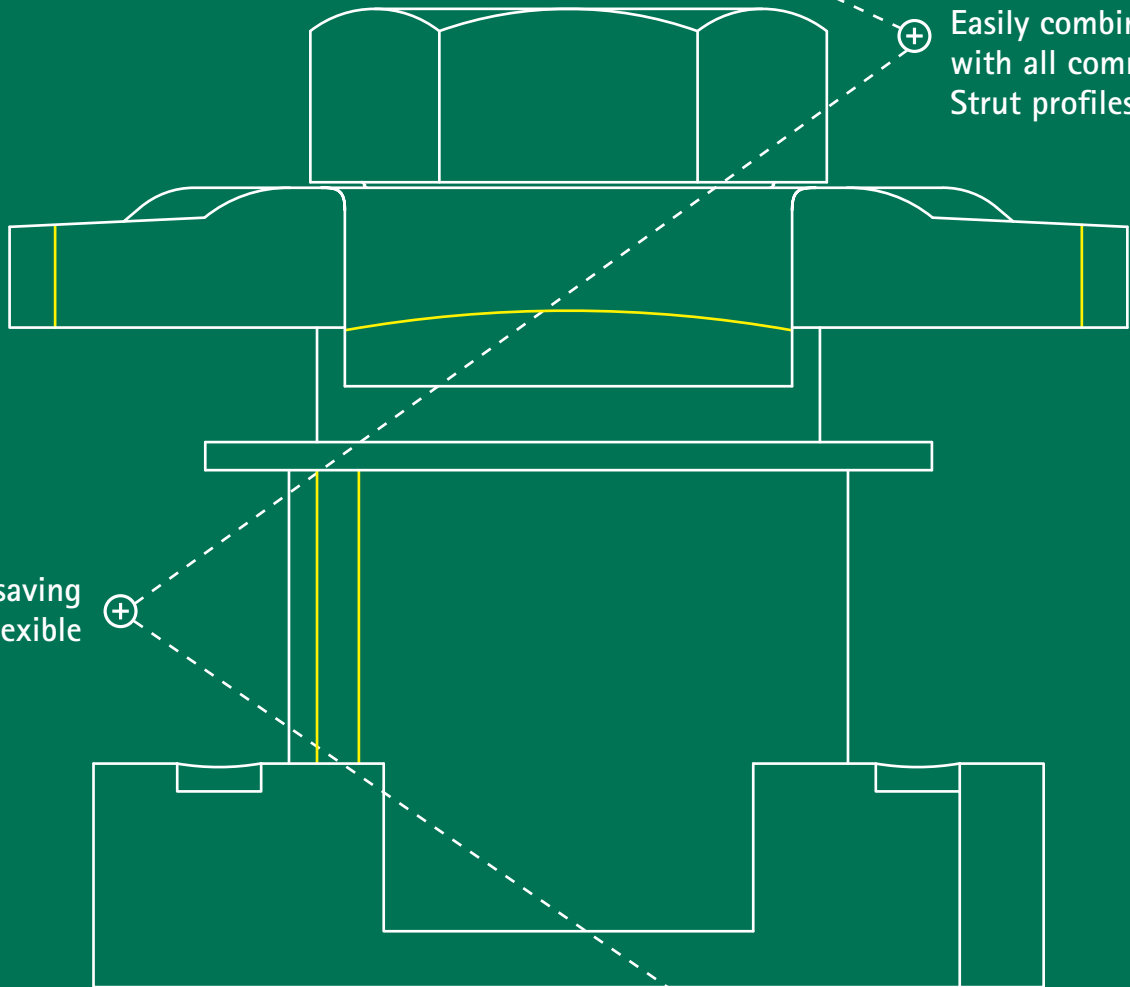

⊕ Easily combined with all common Strut profiles

⊕ Timesaving and flexible

⊕ For easy installation of complex rail constructions

Walraven PushStrut

The quick and safe way to connect



- Timesaving and flexible
- For easy installation of complex rail constructions
- Less parts to do your job
- Products always fit together

Walraven PushStrut Button



66519910

- Universal button: easily combined with all common Strut profiles and all Walraven PushStrut Connectors
- Teeth with force fit connections offer more stability
- Max. allowed load (Fa,z) 5,000 N, shear load 3,000 N*

* The max. allowed load (Fa,z) refers to rails and cantilever arms with a material thickness of 2.5 mm. The Fa,z at a thickness of 2.0 mm profile thickness = 4,500 N. The Fa,z at a thickness of 1.5 mm profile thickness = 3,500 N.

Assembly instruction

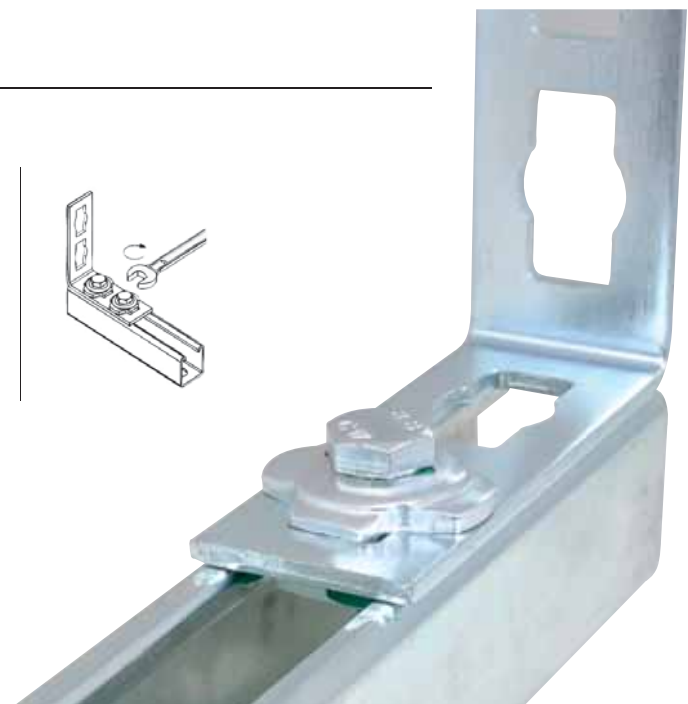
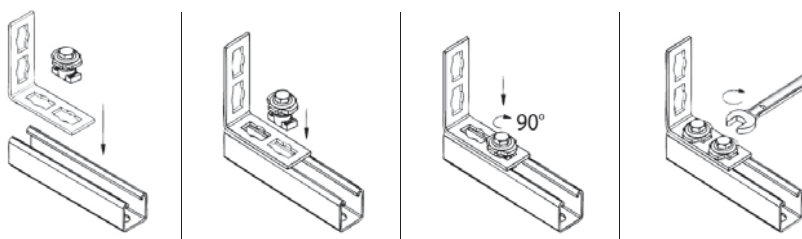

Walraven PushStrut

Easily combined with all common Strut profiles

Walraven PushStrut Connector Flat 90°/135°

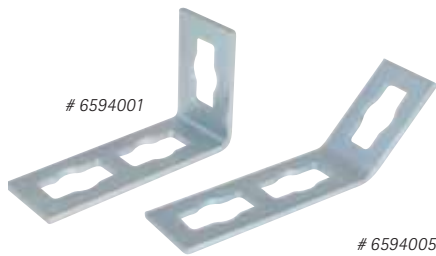

- Flexible use of hole pattern
- Quick and easy to install

Walraven PushStrut Wall Plate



- Stable connection of rails to floor, ceiling or wall
- Timesaving and flexible

Walraven PushStrut Connector Angle Bracket



- Stable rail connection due to fixing to the building

Walraven PushStrut Connector 90° 2-2

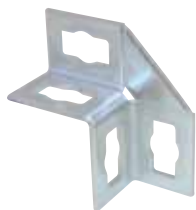

- Lateral edges offer great stability
- Flexible use of hole pattern

Walraven PushStrut Connector 90° 4-4



- Lateral edges offer great stability
- Flexible use of hole pattern

Walraven PushStrut Connector T

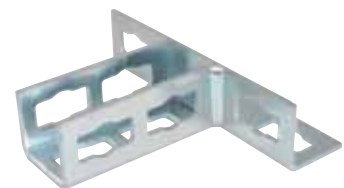

- Stable T-connection due to lateral edges
- Flexible use of hole pattern

Walraven PushStrut 3D Connector 6-3-3-L

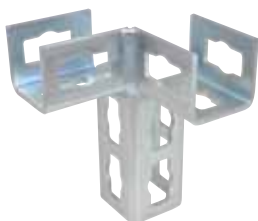

- 3D-Connector for complex frame and rail constructions
- Universal and simple use
- Easy to remove and reusable

Walraven PushStrut 3D Connector 6-3-3-R

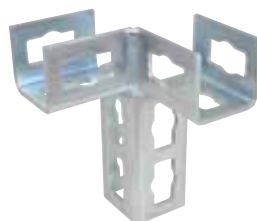

Walraven PushStrut 3D Connector 6-6-3-3

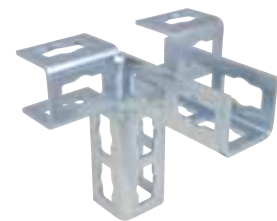

The right combination

Walraven Heavy Duty Clamps

Due to its robust design and solid locking the Walraven Heavy Duty Clamps are perfectly equipped for fixing heavier pipes. The range includes a clamp for each common pipe size. The locking nut is captive, hidden in a plastic nut holder. Moreover the locking screws are provided with anti-loss washers. No more time wasted with incomplete clamps!



■ Walraven HD500

■ Walraven HD1501

Walraven Yeti®

Features and benefits

- For supporting climate installations, solar panels, walkways, etc. on flat roofs
- Adjustable to suit numerous applications
- With non-slip anti-vibration mat for improved installation weight distribution
- A foundation for a solid and reliable installation
- Innovative and multifunctional



Nr. 1762-001-19 ITB No. IZM00-02259



■ Walraven Yeti® 480



■ Walraven Yeti® 335



■ Walraven Yeti® 280



■ Walraven Yeti® 130

Other Walraven accessories and stainless steel

A selection from the range

Besides our unique Walraven RapidStrut® Fixing System we offer a wide range of accessories for safe constructions. Below just a selection of our comprehensive range. For a complete overview please visit our web catalogue at walraven.com.



■ Walraven Strut Floor Bracket



■ Walraven Strut Wall Plate



■ Walraven Strut Wall Plate Hinged



■ Walraven Strut T-Base Plate



■ Walraven Strut T-Bracket



■ Walraven Strut Connector 90°



■ Walraven Strut Connector 90° / 2D



■ Walraven Strut Connector 90° Rigid



■ Walraven Strut Angle Connector 135°



■ Walraven Strut U-Connector linear



■ Walraven Strut Cross Connector



■ Walraven Strut Z-Bracket



■ Walraven Strut Rail Beam Clamp



■ Walraven Strut U-Washer



■ Walraven Strut Inter Flange Clamp



■ Walraven RapidStrut® Slide Nut MS



■ Walraven Strut Slide Nut



■ Walraven Threaded Rod

Stainless Steel

Stainless Steel is specifically designed to be placed in highly corrosive environments as well as spaces with high hygiene standards and possible chemical exposure.

We understand the complexity of selecting the right material in corrosive environments. If you need any help with selecting material, please reach out to us. For more information look at walraven.com/en/stainless-steel.



Additional service & support

From engineering to on-site construction support

Technical design support

Based on your individual requirements our Technical Support staff will deliver you a well grounded proposal with detailed calculations, BIM content, AutoCAD drawings and parts lists.

At Walraven, our service does not end after you have purchased your products. We pride ourselves on our invaluable after sales support and technical advice.



The Walraven specialists are always ready to support!

Prefabrication service

Cutting, grinding, drilling, measuring, they all cost a lot of time on the building site. Not to mention the costs of lost materials or faults. We can prefabricate solutions for you and deliver them directly to the building site.



Find out how we can support you

Would you like to find out more about any of the solutions described in this brochure?
Or would you like to discuss how we could help you find the best possible solution for your project?
Get in touch today!

Singapore

South East Asia & Pacific

Walraven Pte. Ltd.

Tel. +65 6970 0605

customerservice.sg@walraven.com

Walraven Group

Mijdrecht (NL) · Tienen (BE) · Bayreuth (DE) · Banbury (GB) · Malmö (SE) · Grenoble (FR) · Barcelona (ES) · Milan (IT)
Kraków (PL) · Mladá Boleslav (CZ) · Kyiv (UA) · Danville (US) · Shanghai (CN) · Dubai (AE) · Budapest (HU) · Mumbai (IN)
Singapore (SG) · Burlington (CA)



Walraven RapidStrut® (EN-SG) - 10/2024 - PDF - Full content subject to modifications
* The technical data are non-binding and do not reflect the warranted characteristics of the products. They are subject to change. Please consult our General Terms and Conditions. Additional information is available upon request. It is the designer's responsibility to select products suitable for the intended purpose and to ensure that performance data are not exceeded. The installation instructions should always be read and followed.