

System Walraven RapidRail®

Table of rail section properties

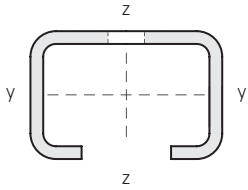

Type	Weight (kg/m)	Yield strength f_{max} (N/mm ²)	Moment of inertia (cm ⁴)		Section modulus (cm ³)	
			I_y	I_z	W_y	W_z
27 x 18 x 1.00	0.479	183.1 *	0.284	0.783	0.274	0.580
30 x 15 x 1.50	0.695	188.3 *	0.282	1.243	0.328	0.829
30 x 20 x 1.25	0.648	185.7 *	0.466	1.317	0.431	0.878
30 x 30 x 1.50	1.054	185.1 *	1.576	2.158	0.951	1.438
30 x 45 x 2.00	1.735	185.7 *	5.006	3.806	2.134	2.537
38 x 40 x 2.00	1.675	188.3 *	3.958	5.044	1.898	2.655

See rail load tables with calculated load values.

At the specified load values, the permissible steel stress f_{max} and a maximum deformation ratio of $L/200$ are not exceeded. Moment of inertia and moment of resistance were calculated with averaged hole pattern.

* The maximum permissible steel stress f_{max} was determined due to the increased yield point as a result of cold Forming according to DIN EN 1993-1-3:2010-12, Section 3.2.2.

On the impact side a safety factor γ_{G10} of 1.4 was taken and on the material side a safety factor γ_M of 1.1.

The overall safety factor γ_{ges} is therefore 1.54.

Perforation pattern for fixing to ceiling or wall

Distance between rail end and first hole is always equal. All sizes in mm.

Walraven RapidRail®

- 27 x 18 mm
- 30 x 15 mm
- 30 x 30 mm

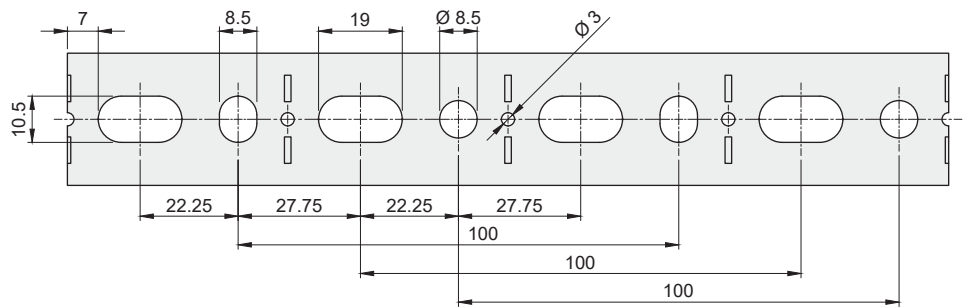

Walraven RapidRail®

- 30 x 20 mm (double side use)

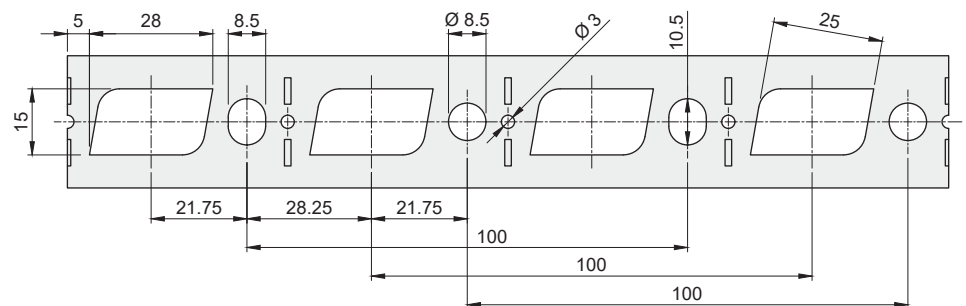

Walraven RapidRail®

- 30 x 45 mm
- 38 x 40 mm

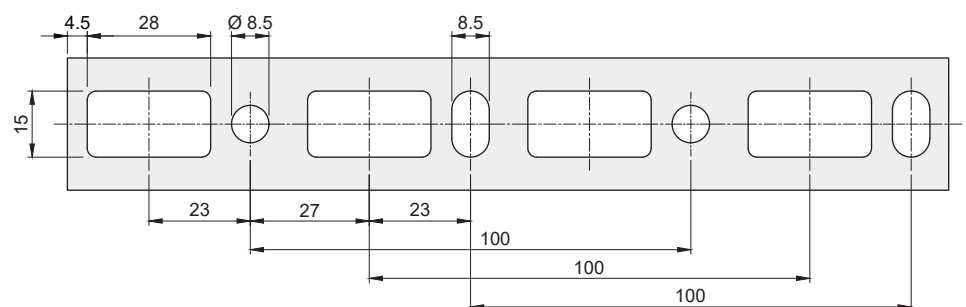

Calculation method

The published safe working loads are calculated with perforated (slotted) rail.

Loads are calculated taking into consideration a maximum deflection (f) of L/200 (according to RAL-GZ 655/B) (see picture 1).

1 N (Newton) = 0.102 kg

1 kg = 9.8 N (Newton)



Picture 1: Calculation of loads, f = maximal deflection, L = length

Fixing of rails to walls or ceilings

The strength of the anchoring of the rail has not been taken into consideration. The installer must verify that the bolts and wall plugs used are suitable for the maximum permitted loading of the rail.

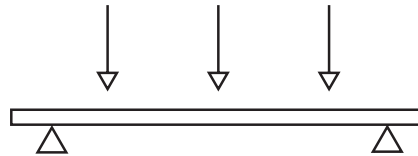

Picture 2: Static load at free bending support

Reading the rail loading tables

The stated values are only valid for the fixing rail. The maximum safe load of all other construction parts have to be verified. The stated maximum safe load is calculated for a static load at free bending support (see picture 2).

Where the segment is marked with a hyphen, the stated length cannot be safely loaded.

Special conditions

In case of doubt or for special conditions not stated in the loading tables, please do not hesitate to contact our technical department for their advice.

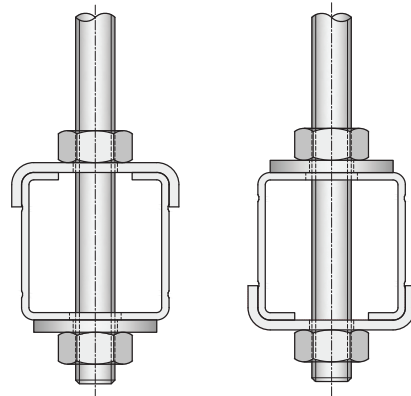

Picture 3: Use of Walraven RapidRail® Washer – U-shaped on the open side of the rail

Hanging of rails from the ceiling

When hanging rails from the ceiling we recommend the use of U-formed washers on the open side of the rail (see picture 3).

Methods of loading

Where loads are suspended beneath rails (e.g. hanging pipes), the load must not exceed the relevant safe load of the Walraven Slide Nut. To increase rigidity of the installation we recommend the use of a U-formed washer (see picture 4).

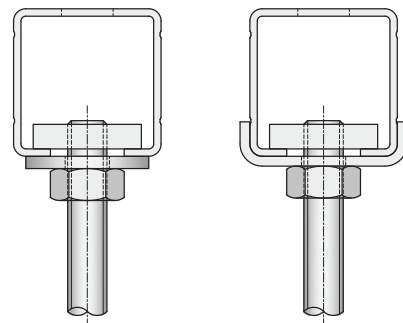





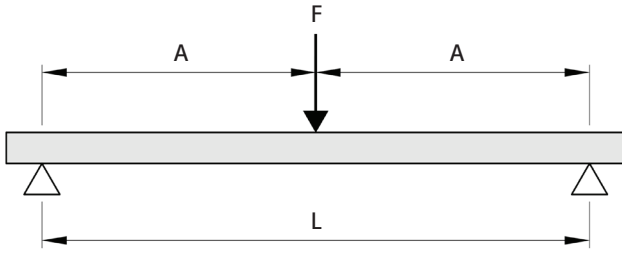

Picture 4: Increase rigidity for loads beneath the rail by using U-shaped washers (right picture) instead of standard flat washers (left picture)

Walraven RapidRail® Fixing rail: suspension on 1 point



L = length, A = equal distances, F = load point

L (mm)						
	27 x 18	30 x 15	30 x 20	30 x 30	30 x 45	38 x 40
250	802	987	1,279	2,814	6,338	5,716
300	668	822	1,066	2,345	5,281	4,763
350	572	704	913	2,009	4,526	4,081
400	500	616	799	1,757	3,959	3,570
450	444	547	710	1,562	3,518	3,173
500	400	492	638	1,405	3,166	2,855
600	333	392	531	1,170	2,636	2,377
700	285	287	455	1,002	2,258	2,036
800	220	218	364	875	1,974	1,780
900	173	171	286	777	1,753	1,581
1,000	139	138	231	698	1,576	1,421
1,200	95	93	158	543	1,310	1,181
1,400	68	66	114	396	1,120	1,003
1,600	51	48	85	299	968	762
1,800	38	36	65	233	759	597
2,000	29	27	50	185	609	478
2,250	21	18	37	142	474	370
2,500	15	12	27	110	377	293
2,750	10	-	20	87	304	235
3,000	-	-	14	68	248	190
3,250	-	-	-	54	204	155
3,500	-	-	-	42	168	126
3,750	-	-	-	32	139	103
4,000	-	-	-	23	115	83
4,250	-	-	-	16	94	66
4,500	-	-	-	10	76	52
4,750	-	-	-	-	61	39
5,000	-	-	-	-	47	28
5,250	-	-	-	-	35	18
5,500	-	-	-	-	24	-
5,750	-	-	-	-	15	-
6,000	-	-	-	-	-	-





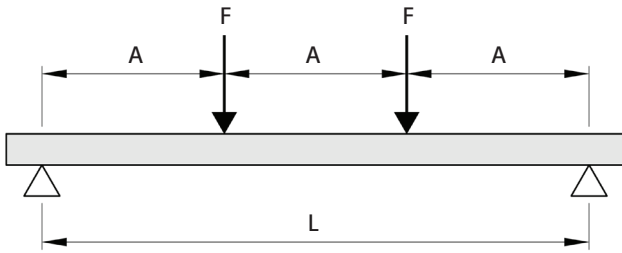

Max. allowed load in N.

The stated values are only valid for the fixing rail.
The maximum safe load of all other construction parts have to be verified.

Walraven RapidRail® Fixing rail: 2 equal loads



L = length, A = equal distances, F = load point

L (mm)						
	27 x 18	30 x 15	30 x 20	30 x 30	30 x 45	38 x 40
250	601	740	959	2,111	4,754	4,287
300	501	616	799	1,758	3,961	3,572
350	429	528	685	1,507	3,394	3,061
400	375	462	599	1,318	2,970	2,678
450	333	410	532	1,171	2,639	2,380
500	300	332	479	1,054	2,375	2,141
600	231	230	381	877	1,978	1,783
700	169	168	279	751	1,694	1,527
800	129	128	213	657	1,481	1,335
900	101	100	168	572	1,315	1,186
1,000	82	81	135	462	1,183	1,066
1,200	56	55	92	319	983	805
1,400	40	39	67	232	746	588
1,600	30	28	50	176	568	447
1,800	22	21	38	137	445	350
2,000	17	15	29	108	357	280
2,250	12	10	22	83	278	217
2,500	-	-	16	65	221	172
2,750	-	-	11	51	178	138
3,000	-	-	-	40	145	112
3,250	-	-	-	31	119	91
3,500	-	-	-	24	99	74
3,750	-	-	-	18	81	60
4,000	-	-	-	13	67	49
4,250	-	-	-	-	55	39
4,500	-	-	-	-	45	30
4,750	-	-	-	-	35	23
5,000	-	-	-	-	28	16
5,250	-	-	-	-	20	10
5,500	-	-	-	-	14	-
5,750	-	-	-	-	-	-
6,000	-	-	-	-	-	-

Max. allowed load in N. per suspension point (F).





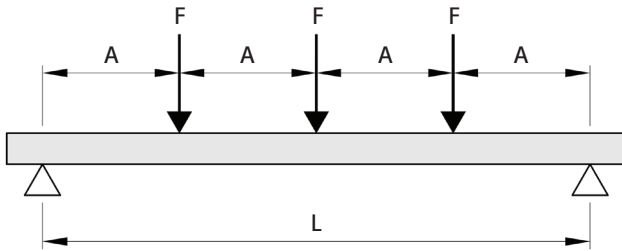

The stated values are only valid for the fixing rail.

The maximum safe load of all other construction parts have to be verified.

Walraven RapidRail® Fixing rail: 3 equal loads



L = length, A = equal distances, F = load point

L (mm)						
	27 x 18	30 x 15	30 x 20	30 x 30	30 x 45	38 x 40
250	401	493	639	1,407	3,169	2,858
300	334	411	533	1,172	2,640	2,381
350	286	352	456	1,004	2,263	2,040
400	250	308	399	878	1,979	1,785
450	222	273	355	781	1,759	1,586
500	200	238	319	702	1,583	1,427
600	166	165	265	585	1,318	1,188
700	121	121	200	501	1,129	1,018
800	93	92	153	437	987	890
900	73	72	120	388	876	790
1,000	58	58	97	331	788	710
1,200	40	39	66	228	655	578
1,400	28	28	48	166	535	422
1,600	21	20	35	126	407	321
1,800	16	15	27	98	319	251
2,000	12	11	21	78	256	201
2,250	-	-	15	59	199	156
2,500	-	-	11	46	158	123
2,750	-	-	-	36	128	99
3,000	-	-	-	28	104	80
3,250	-	-	-	22	86	65
3,500	-	-	-	17	71	53
3,750	-	-	-	13	58	43
4,000	-	-	-	10	48	35
4,250	-	-	-	-	39	28
4,500	-	-	-	-	32	22
4,750	-	-	-	-	25	16
5,000	-	-	-	-	20	11
5,250	-	-	-	-	15	-
5,500	-	-	-	-	10	-
5,750	-	-	-	-	-	-
6,000	-	-	-	-	-	-





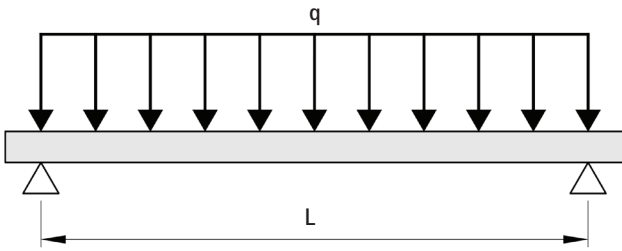

Max. allowed load in N. per suspension point (F).

The stated values are only valid for the fixing rail.

The maximum safe load of all other construction parts have to be verified.

Walraven RapidRail® Fixing rail: Uniformly distributed load



L (mm)						
	27 x 18	30 x 15	30 x 20	30 x 30	30 x 45	38 x 40
250	1,604	1,974	2,559	5,629	12,677	11,433
300	1,336	1,645	2,132	4,690	10,563	9,526
350	1,145	1,409	1,827	4,019	9,052	8,163
400	1,001	1,232	1,598	3,515	7,919	7,141
450	889	1,094	1,420	3,124	7,037	6,346
500	800	907	1,277	2,810	6,332	5,710
600	632	628	1,040	2,340	5,273	4,755
700	463	459	762	2,004	4,517	4,073
800	353	350	582	1,751	3,949	3,561
900	278	275	458	1,555	3,507	3,162
1,000	223	220	369	1,260	3,153	2,842
1,200	153	149	253	869	2,621	2,196
1,400	110	106	182	633	2,035	1,605
1,600	81	78	136	479	1,549	1,220
1,800	62	58	104	373	1,215	955
2,000	47	43	81	296	975	765
2,250	34	29	59	227	759	593
2,500	24	19	44	177	603	469
2,750	17	11	32	139	487	376
3,000	11	-	22	110	397	305
3,250	-	-	14	86	326	248
3,500	-	-	-	67	269	203
3,750	-	-	-	51	223	165
4,000	-	-	-	38	184	133
4,250	-	-	-	26	151	106
4,500	-	-	-	16	122	83
4,750	-	-	-	-	98	63
5,000	-	-	-	-	76	45
5,250	-	-	-	-	57	29
5,500	-	-	-	-	39	15
5,750	-	-	-	-	24	-
6,000	-	-	-	-	10	-



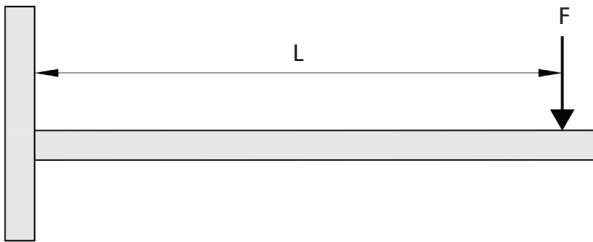

Max. allowed load in N.

The stated values are only valid for the fixing rail.
The maximum safe load of all other construction parts have to be verified.

Walraven RapidRail® Cantilever arms: Suspension on 1 point







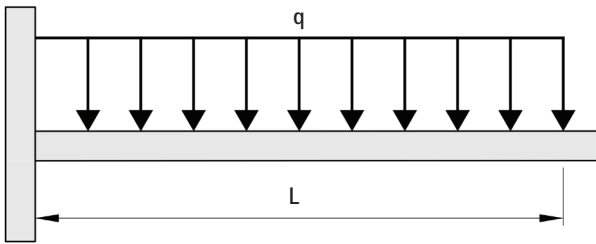

L = length, F = load point

L (mm)					
	27 x 18	30 x 15	30 x 20	30 x 30	38 x 40
100	300	284	312	772	793
150	200	189	208	514	528
200	149	141	155	385	395
250	119	113	124	307	315
300	99	93		256	262
350	85			218	224
400	73			191	195
450	58			169	172
500	46			151	154
550					139
600					127
650					116
700					107
750					99
800					92
850					86
900					80
950					75
1,000					71
1,050					67

Max. allowed load in N.
The maximum safe load of all other construction parts have to be verified.

Walraven RapidRail® Cantilever arms: Uniformly distributed load



L (mm)					
	27 x 18	30 x 15	30 x 20	30 x 30	38 x 40
100	601	569	626	1,544	1,588
150	401	379	417	1,029	1,058
200	300	284	312	771	793
250	240	226	249	616	633
300	199	188		513	527
350	171			439	451
400	149			384	394
450	132			341	349
500	118			306	313
550					284
600					260
650					239
700					221
750					205
800					192
850					180
900					169
950					159
1,000					150
1,050					142

Max. allowed load in N.
The maximum safe load of all other construction parts have to be verified.

Find out how we can support you

Would you like to find out more about any of the solutions described in this Technical Data Sheet?
Or would you like to discuss how we could help you find the best possible solution for your project?
Get in touch today!

Walraven International

Industrieweg 5
3641 RK Mijdrecht (NL)
Tel. +31 297 23 30 00
Fax +31 297 23 30 99
export@walraven.com

Walraven Group

Mijdrecht (NL) · Tienen (BE) · Bayreuth (DE) · Banbury (GB) · Malmö (SE) · Grenoble (FR) · Barcelona (ES) · Milan (IT)
Kraków (PL) · Mladá Boleslav (CZ) · Kyiv (UA) · Danville (US) · Shanghai (CN) · Dubai (AE) · Budapest (HU) · Mumbai (IN)
Singapore (SG) · Burlington (CA) · Athens (GR)

Technical Data Sheet Walraven RapidRail™ Profiles (INT) – 05/2023 – PDF
* The technical data are non-binding and do not reflect the warranted characteristics of the products. They are subject to change. Please consult our General Terms and Conditions. Additional information is available upon request. It is the designer's responsibility to select products suitable for the intended purpose and to ensure that performance data are not exceeded. The installation instructions should always be read and followed.