

Strut – Rail System For all medium rail applications

walraven

Rails

BIS UltraProtect® 1000



walraven

BIS RapidStrut® Fixing Rail 41x21

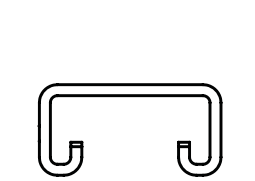

Part No.	L	B (mm)	H (mm)	s (mm)
6501 B 227	2 m	41	21	2,50
6501 B 327	3 m	41	21	2,50
6501 B 427	4 m	41	21	2,50
6501 B 627	6 m	41	21	2,50

BIS RapidStrut® Fixing Rail 41x41

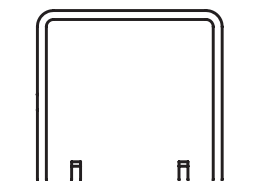

Part No.	L	B (mm)	H (mm)	s (mm)
6501 B 242	2 m	41	41	2,00
6501 B 342	3 m	41	41	2,00
6501 B 442	4 m	41	41	2,00
6501 B 247	2 m	41	41	2,50
6501 B 347	3 m	41	41	2,50
6501 B 447	4 m	41	41	2,50

BIS RapidStrut® Fixing Rail 41x51/62

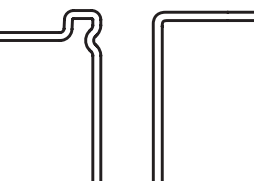

Part No.	L	B (mm)	H (mm)	s (mm)
6505 B 252	2 m	41	51	2,00 (055)
6505 B 352	3 m	41	51	2,00 (055)
6505 B 452	4 m	41	51	2,00 (055)
6501 B 367	3 m	41	62	2,50
6501 B 467	4 m	41	62	2,50
6501 B 667	6 m	41	62	2,50

Rails Pre-galvanized



walraven

BIS RapidStrut® Fixing Rail Double (PG)

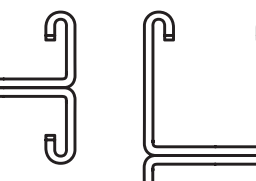

Part No.	L	B (mm)	H (mm)	s (mm)
6503 S 224	2 m	41	21	1,30
6503 S 324	3 m	41	21	1,30
6503 S 424	4 m	41	21	1,30
6503 S 226	2 m	41	21	2,00
6503 S 326	3 m	41	21	2,00
6503 S 426	4 m	41	21	2,00
6503 S 222	2 m	41	21	2,00
6503 S 322	3 m	41	21	2,00

BIS RapidStrut® Fixing Rail 41x21 (PG)

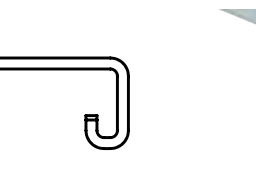

Part No.	L	B (mm)	H (mm)	s (mm)
6505 S 244	2 m	41	21	1,30
6505 S 344	3 m	41	21	1,30
6505 S 444	4 m	41	21	1,30
6505 S 246	2 m	41	21	2,00
6505 S 346	3 m	41	21	2,00
6505 S 446	4 m	41	21	2,00
6505 S 242	2 m	41	21	2,00
6505 S 342	3 m	41	21	2,00

BIS RapidStrut® Fixing Rail 41x41 (PG)



Part No.	L	B (mm)	H (mm)	s (mm)
6505 S 244	2 m	41	41	1,30
6505 S 344	3 m	41	41	1,30
6505 S 444	4 m	41	41	1,30
6505 S 246	2 m	41	41	2,00
6505 S 346	3 m	41	41	2,00
6505 S 446	4 m	41	41	2,00
6505 S 242	2 m	41	41	2,00
6505 S 342	3 m	41	41	2,00

BIS RapidStrut® Fixing Rail 41x41 (PG)

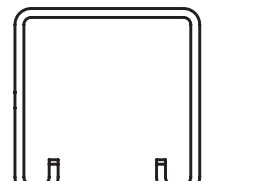

Part No.	L	B (mm)	H (mm)	s (mm)
6505 S 244	2 m	41	41	1,30
6505 S 344	3 m	41	41	1,30
6505 S 444	4 m	41	41	1,30
6505 S 246	2 m	41	41	2,00
6505 S 346	3 m	41	41	2,00
6505 S 446	4 m	41	41	2,00
6505 S 242	2 m	41	41	2,00
6505 S 342	3 m	41	41	2,00

BIS RapidStrut® Fixing Rail 41x62/82 (PG)

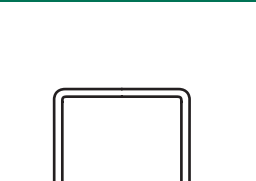

Part No.	L	B (mm)	H (mm)	s (mm)
6503 B 365	3 m	41	62	2,50
6503 B 465	4 m	41	62	2,50
6503 B 385	3 m	41	82	2,50
6503 B 485	4 m	41	82	2,50

Cantilever Arms



walraven

BIS RapidStrut® Cantilever Arm 41x21



Part No.	L	B (mm)	H (mm)	s (mm)
660 3 831	200 mm	41	21	2,50
660 3 832	300 mm	41	21	2,50
660 3 833	400 mm	41	21	2,50
660 3 834	600 mm	41	21	2,50

BIS RapidStrut® Cantilever Arm 41x41



Part No.	For rail	L
660 3 923	Strut 41 x 41 x 0,0	300 mm
660 3 926	Strut 41 x 41 x 2,0	400 mm
660 3 928	Strut 41 x 41 x 2,0	600 mm
660 3 981	Strut 41 x 41 x 2,5	150 mm
660 3 870	Strut 41 x 41 x 2,5	200 mm
660 3 962	Strut 41 x 41 x 2,5	300 mm
660 3 971	Strut 41 x 41 x 2,5	400 mm

BIS RapidStrut® Cantilever Arm 41x41D



Part No.	For rail	L
660 3 983	Strut 41 x 41 x 2,5	450 mm
660 3 973	Strut 41 x 41 x 2,5	600 mm
660 3 984	Strut 41 x 41 x 2,5	750 mm
660 3 985	Strut 41 x 41D x 2,5	1000 mm
660 3 986	Strut 41 x 41D x 2,5	1200 mm
660 1 894	41 x 41 x 2,5 with Rail Prop (HDG)	600 mm

BIS RapidStrut® Cantilever Arm 41x21D



Part No.	For rail	L
660 3 883	Strut 41 x 41D x 2,5	450 mm
660 3 884	Strut 41 x 41D x 2,5	600 mm
660 3 885	Strut 41 x 41D x 2,5	750 mm
660 3 886	Strut 41 x 41D x 2,5	1000 mm
660 3 887	Strut 41 x 41 x 2,5	1200 mm

BIS RapidStrut® Cantilever Arm 41x21



Part No.	For rail	L
660 3 828	Strut 41 x 21 vertical	300 mm
660 3 829	Strut 41 x 21 vertical	600 mm

Beam Fixings



walraven

BIS Strut HD Beam Clamp / Sets



Part No.	For rail	L
607 2 002	Strut	-
607 3 300	Strut 41 x 21D	300 mm
607 3 600	Strut 41 x 21D	600 mm
607 3 800	Strut 41 x 21D	800 mm

BIS Strut Rail Beam Clamp (HDG)



Part No.	For rail	Beam
6658 1 711	Strut 41 x 21 + 41 x 41 x 21D	<= 20 mm
6658 1 721	Strut 41 x 41 + 41 x 41 x 21D + 41 x 41D + 05 5 (41 x 51)	<= 20 mm

BIS Strut Inter Flange Clamp

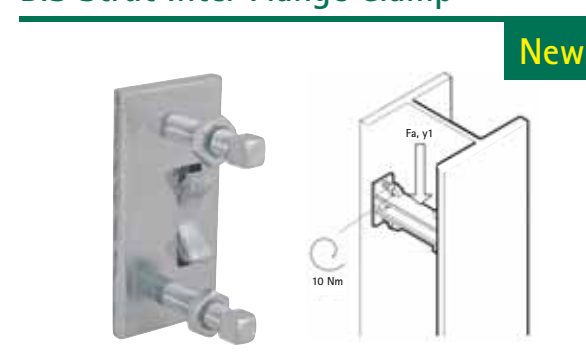

Part No.	For rail
607 B 021	Strut 41 x 21
607 B 041	Strut 41 x 41 + 41 x 21D

BIS Strut Rail Beam Clamp (ZP)

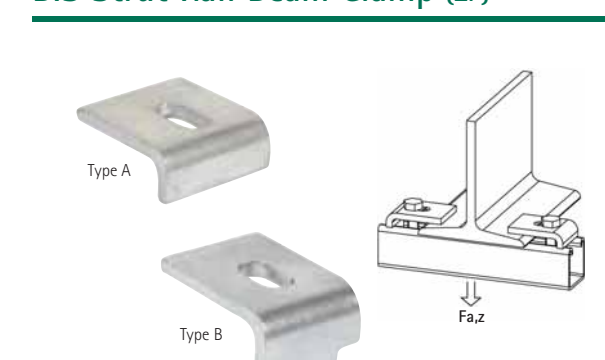

Part No.	Type	d1 (mm)
6658 3 741	A	22 x 11
6658 3 761	B	22 x 11

BIS Strut Beam Clamp (ZP)



Part No.	For rail	G
6658 3 736	Strut 41 x 41 + 41 x 21D	M12

Base plates, Triangles and Props Arms



walraven

BIS RapidStrut® Base Plate G2



Part No.	For rail	L
6658 85 400	Strut 41 x 41, 41 x 62, 41 x 82	107 mm

BIS Strut Base Plate G2 (ZP)



Part No.	For rail	L
6658 3 804	Strut 41 x 41, 41 x 62, 41 x 82	107 mm

BIS Strut T-shape Base Plate



Part No.	For rail	L
6658 3 361	Strut 41 x 21, 41 x 41	138 mm

BIS Strut Base Plate HD



Part No.	For rail	H (mm)
6658 8 641	Strut 41 x 41 + 41 x 21D	157
6658 8 662	Strut 41 x 62 + Strut 41 x 41D	157

BIS Strut Wall Plate (Hinged)



Part No.	For rail	Strut
6658 8 814	Strut	

BIS Strut T-Bracket (ZP)



Part No.	For rail	Beam
6658 3 801	Strut 41 x 21 + 41 x 41 x 21D	Horizontal
6658 3 802	Strut 41 x 21 + 41 x 41 x 21D	Vertical

BIS Strut Floor Bracket (ZP)



Part No.	For rail	L
6658 3 602	Strut 41 x 41	120 mm

BIS Rail Junction Angle Bracket

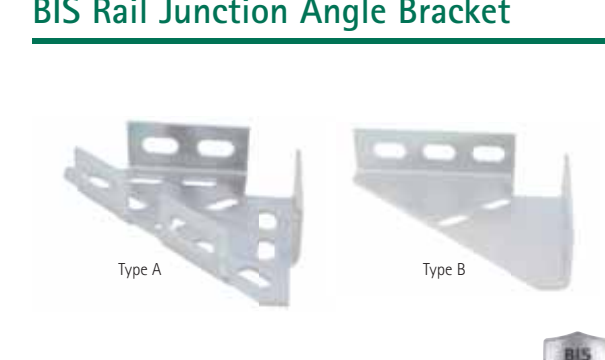

Part No.	Type	L
6603 8 020	A	200 x 200 mm
6603 8 020	B	200 x 200 mm

BIS Rail Prop



Part No.	For rail	L
6658 8 530	Strut + WM35	300 mm

Connectors



walraven

BIS RapidStrut® Rail Connector

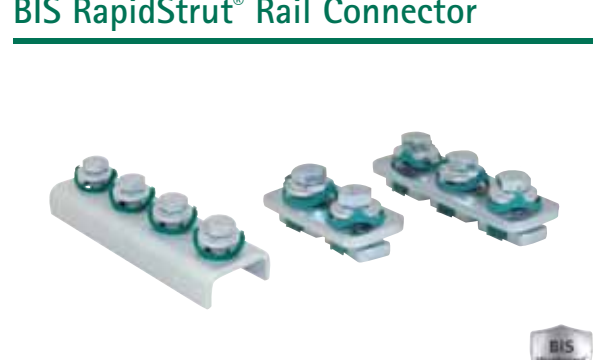

Part No.	Type	L
6658 85 421	U-shaped	163 mm
6658 85 184	Flat x 1	182 mm
6658 85 186	Flat x 2	164 mm

BIS RapidStrut® Rail T/X Connector G2



Part No.	Type	For rail
6658 85 213	T	Strut
6658 85 223	X	Strut

BIS RapidStrut® Cross Connector G2



Part No.	For rail	Strut 41 x 21	Strut 41 x 41
6658 85 400		Strut 41 x 41	
6658 85 405		Strut 41x41 (BIS-RapidStrut® DS S)	
6658 85 406		Strut 41 x 62	
6658 85 408		Strut 41 x 82	

BIS RapidStrut® Rail Connector 90° G2



Part No.	For rail	Strut	L
6658 85 102		62 x 42 mm	
6658 85 201		62 x 62 mm	
6658 85 202		103 x 62 mm	
6658 85 205		103 x 103 mm	

BIS RapidStrut® Rail Connector 135° G2



Part No.	For rail	L
6658 85 216	Strut	102 x 51 mm
6658 85 230	Strut	102 x 91 mm

BIS Strut U-Connector linear



Part No.	For rail	Strut	L
6658 8 171	Strut 41 x 21 + 41 x 41 x 21D		175 x 20 x 4 mm
6658 8 181	Strut 41 x 41D + 41 x 62D + 41 x 82		175 x 42 x 4 mm

BIS Strut Connector 90° rigid



Part No.	For rail	Strut	L
6658 8 291	Strut	91 x 91 x 6 mm	

BIS Strut Connector 90° / 2D

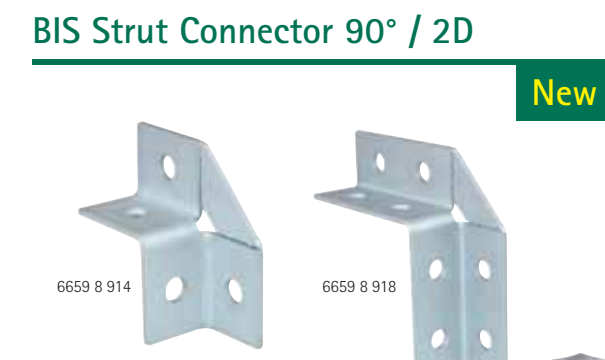

Part No.	For rail	Strut	L
6658 8 914	Strut	110 x 110 mm	
6658 8 918	Strut	60 x 60 mm	

BIS Strut T-Connector



Part No.	For rail	Strut	L
665 89 301	Strut	131 x 80 mm	

BIS Strut Cross Connector

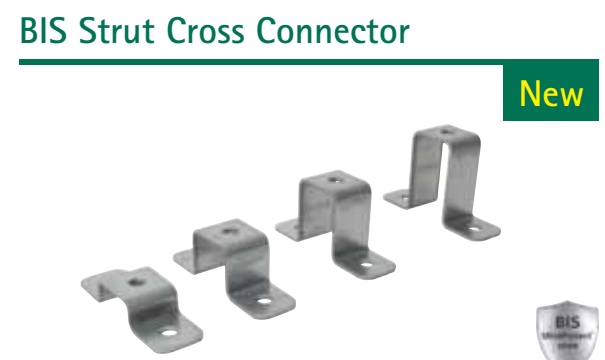

Part No.	For rail	L
6658 8 292	Strut 41 x 21	135 mm
6658 8 294	Strut 41 x 41	135 mm
6658 8		



Strut-Rail System

For all medium rail applications

walraven.com

BIS UltraProtect® 1000



Optimal protection

- All applied surface treatments effortlessly withstand a salt spray test of at least 1000 hours*
- Suitable for corrosive environments (C1-C4 in accordance with ISO 12944-2)



Better than Hot Dip Galvanizing

- Higher corrosion resistance: 1000 hours* versus 300 - 600 hours (with a layer thickness of 50 - 80 µm)
- Threaded products are also well protected
- Products feel smooth and are also visually appealing



* Until the occurrence of maximum 5% red rust.

Complementary system

- The products in the BIS UltraProtect® 1000 System combine together perfectly
- Can also be combined with zinc plated, pre-galvanized or hot dip galvanized products



A selection

