

From design to  
ready-to-install systems

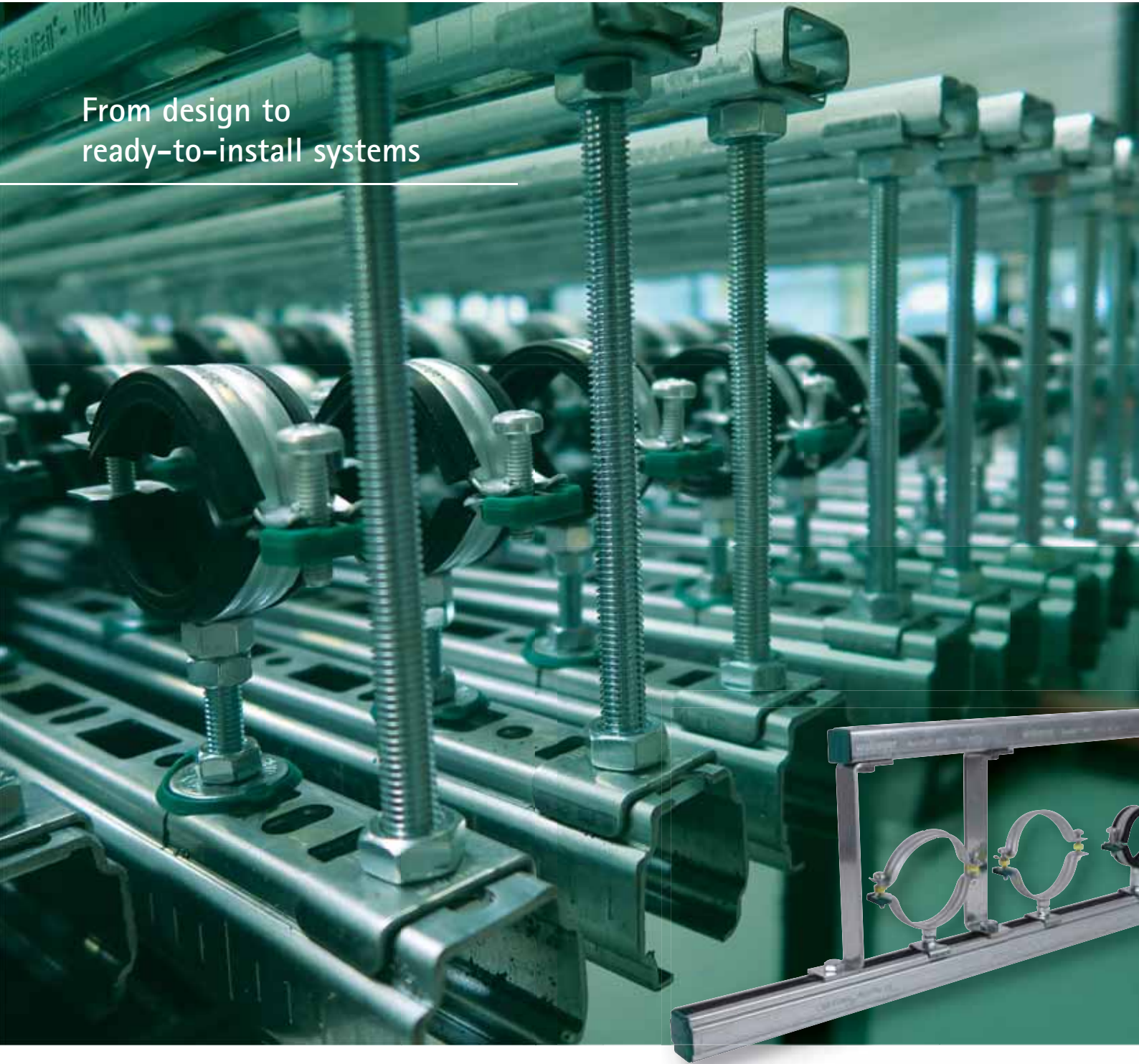

## Prefab & Modular MEP Systems

Your partner for the design, production and assembly  
of Pre-fabricated Modular MEP Systems

Prefab solutions

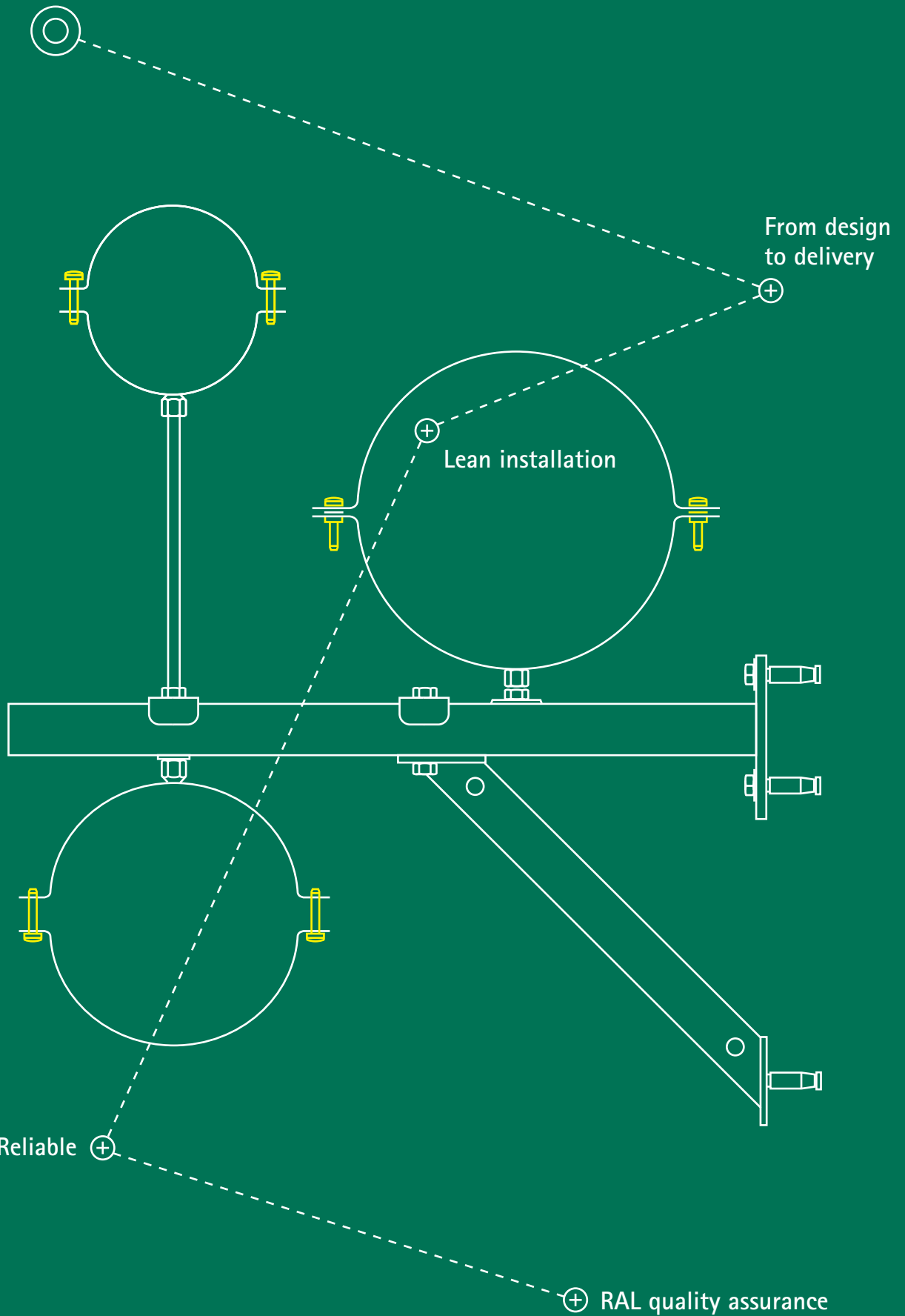

## Inspired by smart solutions from the start

Walraven is a globally active company in the installation industry, founded in 1942. We have always been dedicated to make the work of our customers easier and more effective. With simple and smart solutions, comprehensive services and excellent support.

Walraven. The value of smart

# About Walraven



## Walraven Group

The Walraven Group, with its headquarters in Mijdrecht, the Netherlands, is today an internationally active enterprise with its own production facilities and sales offices in various countries. The Walraven Group has over 1000 employees. Walraven products are used by tens of thousands of installation companies in Europe, North America, Latin America, Africa, the Middle East, Asia and Australia. Walraven products are applied in housing, utility, industrial and infrastructural projects.

## Decades of experience

Since 1942 our products and know-how have been renowned for top quality. Decades of experience, together with the skills of our professional staff, form the solid foundations of our company. We are proud of our history.

## Innovation

Developing and implementing innovative technical ideas enjoys a high priority at Walraven. The starting point is ease of use and time saving during installation coupled with an optimum in reliability.

## Smart system solutions

Each individual product is an important part of a total system solution. Walraven products are market oriented, innovative and fitting the needs of the customer. We offer system solutions in the field of fixing, fire protection and sanitary. Combined with our extensive technical sales support you can rely on a complete offering.



*Offering reliability and high quality*

# Walraven means quality

ISO 9001:2015 certified



Walraven means quality. That is why our organisation is ISO 9001:2015 certificated. This guarantees the ambition to achieve continuous improvement of company procedures and thereby the quality of our entire organisation.

## Product quality

Many of our products satisfy specific quality benchmarks and standards, which are required for specific applications. Amongst other tests, our products are continuously tested for safety limits. These tests take place in-house, as well as in testing institutes which are officially accredited. This provides an extra guarantee that Walraven products comply with the most stringent quality standards.

Safe Connection (RAL-Quality hallmark)

Walraven is one of the founding members of the 'Gütegemeinschaft Rohrbefestigung' (Safe Connection). This association, consisting of the most important manufacturers of pipe fixing systems, has established clear guidelines and testing procedures.

This makes it easier to compare the technical properties, such as the maximum permissible load of pipe fixing products under normal conditions and during fire.

The 'Gütegemeinschaft Rohrbefestigung' was acknowledged in 2003 by RAL, the German institute for quality care.



*Extra guarantee by the most stringent quality standards*

# Smart system solutions

## Pipe Clamps



■ starQuick®, Bifix® G2 and BIS HD Clamps

## Rail

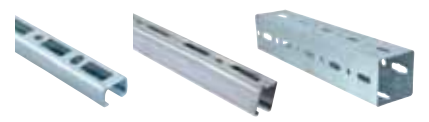

■ BIS RapidRail®, BIS RapidStrut® and Maxx Rail

## Rooftop Support

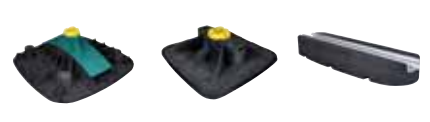

■ BIS Yeti® and BIS Ursus®

## Fixing Accessories



■ Rail Accessories, Light and HD Anchors

## Britclips®

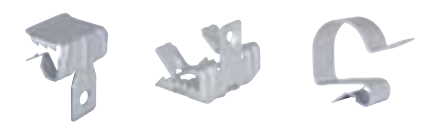

■ Beam Clips, Cable Run Clips and Conduit Clips

## Fire Protection



■ Pacifyre® Fire Sleeves, Collars and Sealants

# Prefab & Modular MEP Systems

In addition to the standard range, Walraven offers Prefabricated and Modular MEP Systems. Together with a highly qualified engineering department, Walraven can offer solutions, if needed certified. Thinking along, experience, knowledge and excellent service are the reasons for choosing Walraven as a partner for Prefab and Modular MEP System related questions.

## A reliable and valuable partner

Walraven has extensive experience in the design, production and assembly of Modular MEP Systems. If needed we offer the possibility to deliver the solution prefabricated and thereby speed up the installation process. By taking control of the entire process, we are able to deliver exactly what fits the specific demand. Due to the worldwide participation in successful projects and the experience gained, Walraven is a reliable and valuable partner.

## Service

We are committed to offer you great services. Whether it is a reliable and accurate advice, solutions for specific questions or just-in-time delivery on location; the Walraven specialists are always ready to support!

## BIM

For all of our products we are working on creating BIM models. As and when they become available they will be placed on the BIMObjects website. By doing so every project can benefit from our models to design and check proposed solutions. After construction the information of our models is very useful in relation to facility management.

We offer you Revit Families (LOD350 and higher), Revit and BIM support and assistance on implementation.

**bimobject**

[www.bimobject.com/walraven](http://www.bimobject.com/walraven)



■ Modular MEP Systems



■ Prefab

*The Walraven specialists are  
always ready to support!*



# Everything under one roof



Common project definition

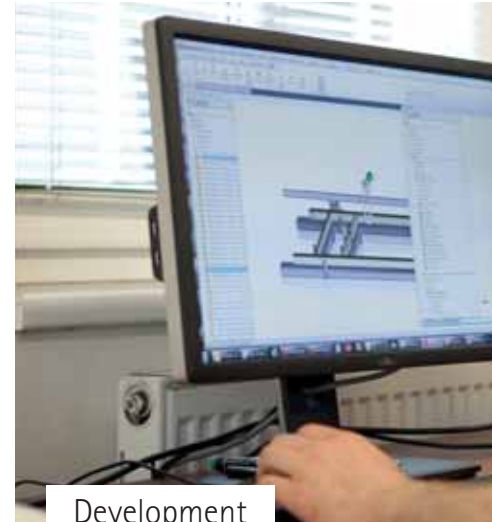

Development



Production



Quality assurance



Logistics





Tooling



Production



Service

## A selection of the possibilities



All-in-one frames



Horizontal pipe supports



Fix points

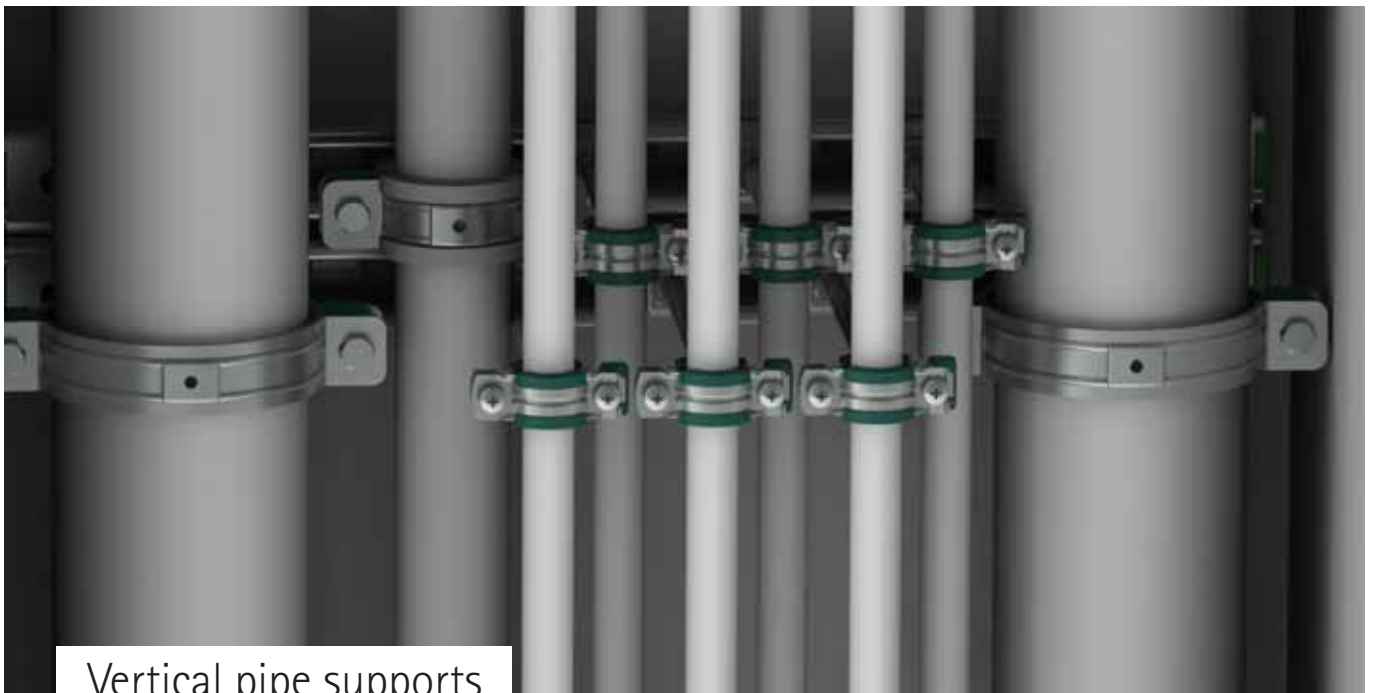

Vertical pipe supports

# Walraven Project Engineering

Together we will find the best solution

---

Working with fixing and fire protection systems becomes more and more complex due to advancing technology and changing building requirements. When preparing or executing a project you may encounter a problem that you cannot solve yourself. Walraven Project Engineering has vast experience in solving technical problems.

From engineering to on-site construction support

---

Around our products we offer technical support around fixings for pipes, air ducts or cable ducts, constructions for technical installations on roofs such as solar panels or climate installations, auxiliary constructions (frames), pipe and cable penetrations through fire rated separations, et cetera.

Among other things we offer:

- Full service: from project drawings to technical support on location;
- Detailed quotes for a cost-saving solution;
- Specialised support for a variety of issues;
- Prefab solutions;
- Revit / BIM support.

Our expertise is available to you!

---

Based on your individual requirements our Project Engineering staff deliver you a proposal, well grounded with detailed calculations, 3D CAD/Revit-drawings, parts lists and quotes.

In short, our expertise is available to you!

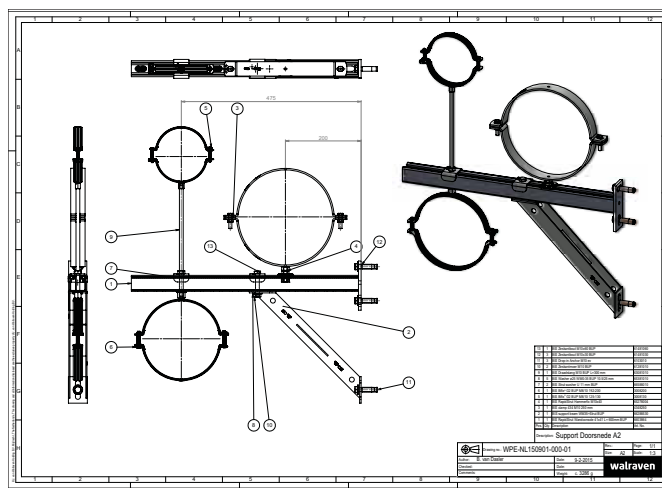
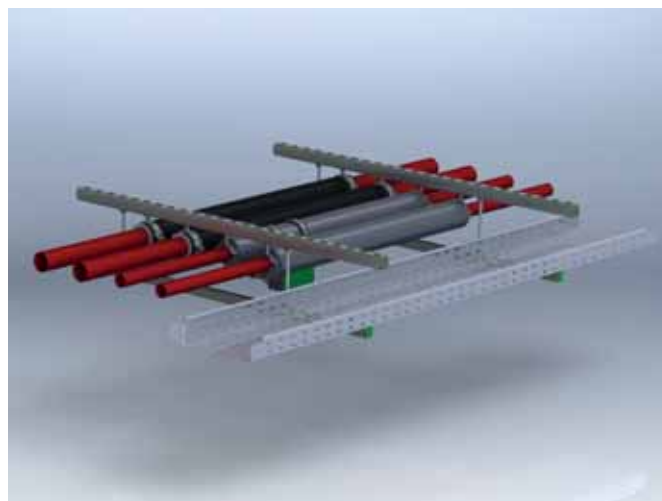

*Extensive experience  
in solving technical  
challenges*

# Walraven Group



## Walraven

Walraven is a manufacturer of a wide range of technical installation materials, with an emphasis on fixing systems, fire protection systems and sanitary systems. Since its founding in 1942, the family business has grown into an international company with more than 1000 skilled employees and its own sales and production sites in various countries in Europe.

Our employees think in solutions and are happy to assist you with well grounded advice and technical support. All this in close collaboration with specialised wholesale partners and distributors. Thanks to them Walraven products always close by and available at the right time in Europe, North and South America Middle East, Asia and Australia.

## Head office

J. van Walraven Holding B.V.  
Mijdrecht (NL)

## 17 Sales companies

### Mijdrecht (NL)

Walraven B.V.  
The Netherlands

### Mijdrecht (NL)

Walraven International  
Other countries

### Tienen (BE)

Walraven BVBA  
Belgium - Luxembourg

### Bayreuth (DE)

Walraven GmbH  
Germany - Austria - Switzerland  
Italy - South East Europe

### Grenoble (FR)

Walraven France Eurl  
France

### Banbury (UK)

Walraven Ltd.  
United Kingdom - Ireland

### Mladá Boleslav (CZ)

Walraven s.r.o.  
Czech republic - Slovak republic

### Kraków (PL)

Walraven Sp. z o.o.  
Poland - Lithuania - Latvia - Estonia

### Kyiv (UA)

Walraven Ltd.  
Ukraine

### Barcelona (ES)

Walraven Iberia S.L.  
Spain - Portugal

### Detroit (US)

Walraven, Inc.  
United States of America - Canada

### Moscow (RU)

Walraven LLC  
Russia

### Shanghai (CN)

Walraven Shanghai, Ltd.  
China

### Malmö (SE)

Walraven Nordic AB  
Sweden - Denmark - Norway - Finland - Iceland

### Dubai (AE)

Hira Walraven  
Middle East

### Budapest (HU)

Walraven Kft.  
Hungary - Romania

### Mumbai (IN)

Diamond Walraven

### Singapore (HUB)

Walraven Pte. Ltd.

## BIM Engineering Department Contact

Email: [customerservice.sg@walraven.com](mailto:customerservice.sg@walraven.com)

Contact Number: +65 6970 0605



The value of smart



## 11 Production / assembly companies

<b>Mijdrecht (NL)</b> J. van Walraven B.V.	<b>Cista (CZ)</b> Suchánek & Walraven s.r.o.	<b>Horka (CZ)</b> Suchánek & Walraven s.r.o.	<b>Barcelona (ES)</b> Walraven Iberia S.L.	<b>Banbury (UK)</b> Walraven Ltd.	<b>Istanbul (TR)</b> Jefleks Plastik Kauçuk
<b>Gramsbergen (NL)</b> Loko Gramsbergen B.V.	<b>Horka (CZ)</b> SWO Tooling s.r.o.	<b>Changshu (CN)</b> Walraven Metal Products (Changshu) Co. Ltd	<b>Detroit (US)</b> Walraven, Inc. United States of America - Canada	<b>Mumbai (IN)</b> Diamond Walraven	

## Find out how we can support you

Would you like to find out more about any of the solutions described in this brochure?

Or would you like to discuss how we could help you find the best possible solution for your project? Get in touch today!

### Singapore

South East Asia & Pacific

#### Walraven Pte. Ltd.

71 Lorong 23 Geylang #06-14  
388386 Singapore (SG)  
[customerservice.sg@walraven.com](mailto:customerservice.sg@walraven.com)

### Walraven Group

Mijdrecht (NL) · Tienen (BE) · Bayreuth (DE) · Banbury (GB) · Malmö (SE) · Grenoble (FR) · Barcelona (ES) · Kraków (PL)  
Mladá Boleslav (CZ) · Moscow (RU) · Kyiv (UA) · Detroit (US) · Shanghai (CN) · Dubai (AE) · Budapest (HU) · Mumbai (IN)  
Singapore (SG)