

Britclips® FC M6 x 9

for flange 2 - 30 mm

(J 05 25)

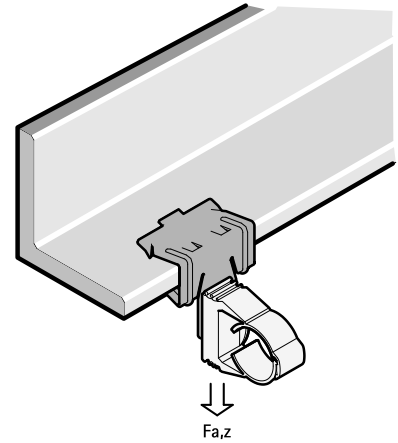

Features and Benefits

- for a solid fixing to steel construction without the need for welding or drilling
- with stud bolt M6 x 9 mm for fixing of clamp, conduit junction box, etc.
- material: spring steel (type C67S according to EN10132)
- surface treatment: Delta-Tone 9000 (480 hours)

Part No.	Code	A (mm)	h (mm)	F _{a,z} (N)	Pack 1	Pack 2
50520604	FC4 M6x9	2 - 4	27	450	100	500
50520609	FC8 M6x9	4 - 8	39	450	100	400
50520616	FC14 M6x9	8 - 14	41	450	100	400
50520620	FC20 M6x9	14 - 20	47	450	100	400
50520630	FC28 M6x9	20 - 28	50	450	100	400

For use with static loads only.

