

BISMAT[®] 2000 'S'

for steam pipes 15 - 63 mm

M8/10

(A 05 32)

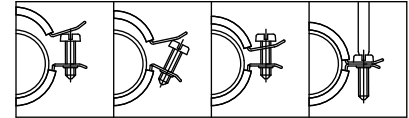

Features and Benefits

- single screw clamp
- with BISMAT[®] quick locking system
- clamp easy to close with one hand
- material: steel
- zinc plated
- noise insulating lining of silicone rubber, reddish brown, heat resistant up to 210 °C
- age resistant lining
- sound insulating lining according DIN 4109
- tested for fire safety



RAL-GZ 655/B
Cert.Nr. 2010-22



RAL-GZ 656
Cert.Nr. 2011-11

Part No.	D (mm)	D (°)	DN	G	B (mm)	H (mm)	h (mm)	b x s (mm)	cs	F _{a,z} (N)	RAL	Pack 1
3404018	15 - 18	3/8	10	M8/10	48	44.0	30	20 x 1.00	M6	600	RAL ²	50
3404023	20 - 23	1/2	15	M8/10	55	47.0	31	20 x 1.00	M6	600	RAL ²	50
3404028	25 - 28	3/4	20	M8/10	60	52.0	34	20 x 1.00	M6	600	RAL ²	50
3404035	31 - 35	1	25	M8/10	67	59.0	38	20 x 1.00	M6	600	RAL ²	50
3404043	40 - 43	1 1/4	32	M8/10	75	68.0	42	20 x 1.25	M6	800	RAL ²	50
3404053	48 - 52	1 1/2	40	M8/10	85	74.0	45	20 x 1.25	M6	800	RAL ²	50
3404063	57 - 63	2	50	M8/10	94	86.0	51	20 x 1.25	M6	800	RAL ²	50

RAL² = tested, certified and monitored by a third party according to RAL-GZ 655/B and RAL-GZ 656.
For detailed technical information about our RAL marked products, please see the RAL datasheet in our web catalogue.

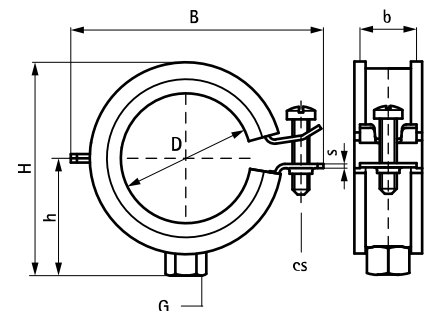

Complementary

- Walraven RapidRail[®] Fixing System
- Walraven Fixing Accessories
- Walraven Fastenings