

BIS Floor Clamp

for floor pipe \varnothing 16 - 40 mm

(0 15 05)



391 3 0XX

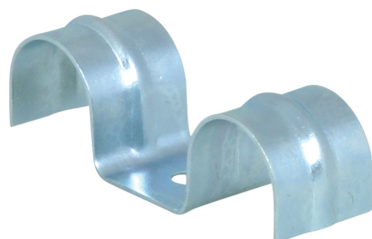

391 3 2XX

Features and Benefits

- one-part saddle
- to fix pipe-in-pipe pipes before casting top floor layer
- increased strength due to profiled shape
- material: steel
- zinc plated

Part No.	D (mm)	Model	B (mm)	s (mm)	k (mm)	Pack 1	Pack 2
3913016	16	Single	43	1.0	-	250	1,000
3913020	20	Single	47	1.0	-	250	1,000
3913025	25	Single	52	1.0	-	250	1,000
3913028	28	Single	55	1.0	-	250	1,000
3913216	16	Double	61	1.0	41	250	500
3913220	20	Double	69	1.0	45	250	500
3913225	25	Double	79	1.0	50	250	500
3913228	28	Double	85	1.0	53	250	500

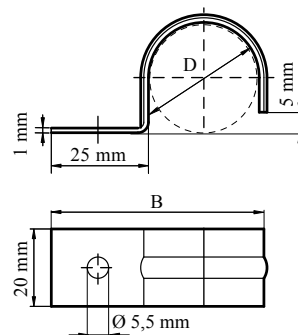

391 3 0XX

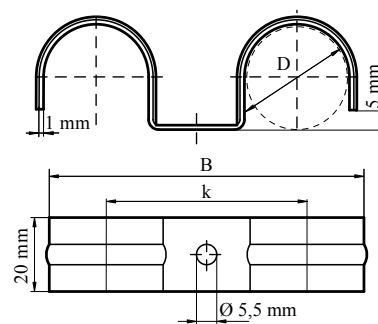

391 3 2XX

Complementary
BIS Shouldered Masonry Nail