

Mocowania do  
instalacji elektrycznych



Mini Katalog 2023



# Klipsy do dźwigarów & Klamry do dźwigarów

## Britclips® FC Klipsy do dźwigarów

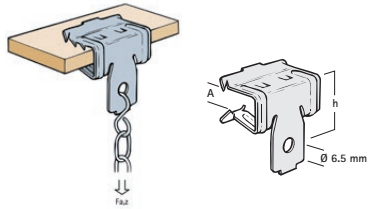

Nr kat.	A (mm)	H (mm)	Fa,z (N)	Opak. (szt.)
50020004	2 - 4	27	450	100
50020009	4 - 8	39	950	100
50020016	8 - 14	41	950	100
50020020	14 - 20	47	950	100
50020030	20 - 28	56	950	400

## Britclips® FU Klipsy do dźwigarów

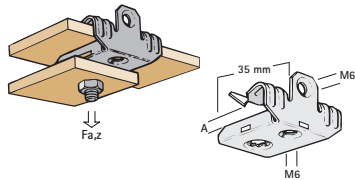

Nr kat.	A (mm)	Fa,z (N)	Opak. (szt.)
51420607	3.0 - 7.0	450	100
51420613	8.0 - 12.5	450	100
51420620	14.0 - 20.0	450	100
51520607	3.0 - 7.0	450	100
51520613	8.0 - 12.5	450	100
51520620	14.0 - 20.0	450	100

## Britclips® SB Klamry do dźwigarów

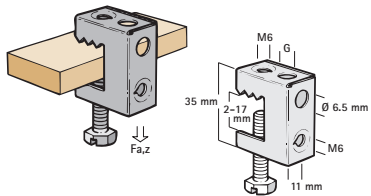

Nr kat.	G (mm)	Fa,z (N)	Opak. (szt.)
53420717	Ø 6.5	550	100
53421117	Ø 11.0	550	100

## Britclips® FC6 MR Klipsy do dźwigarów z gniazdem gwintowanym

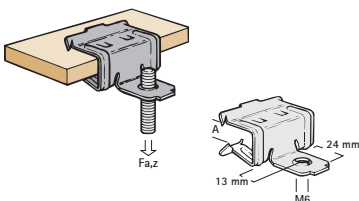

Nr kat.	A (mm)	Fa,z (N)	Opak. (szt.)
50425609	4 - 8	150	100
50425616	8 - 14	150	100

## Britclips® PHV Wieszaki do kształtowników L

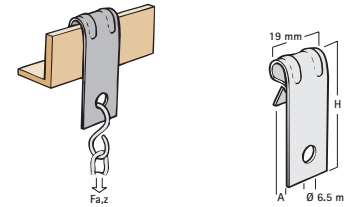

Nr kat.	A (mm)	H (mm)	Fa,z (N)	Opak. (szt.)
57020005	5 - 7	40	720	100

## Britclips® FC ICT Klipsy do dźwigarów z uchwytem dla prętów

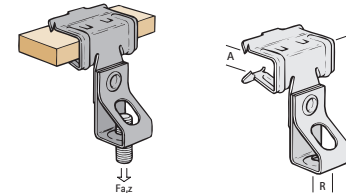

Nr kat.	A (mm)	H (mm)	R (mm)	Fa,z (N)	Opak. (szt.)
50420609	4 - 8	51	M6	680	100
50420809	4 - 8	51	M8	680	100
50420616	8 - 14	56	M6	680	100
50420816	8 - 14	56	M8	680	100

## Britclips® PHV ICT Wieszaki do kształtowników L z uchwytem dla prętów

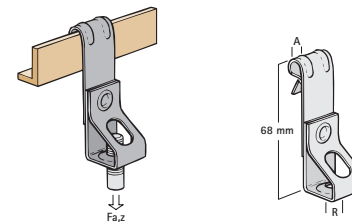

Nr kat.	A (mm)	R (mm)	Fa,z (N)	Opak. (szt.)
57420605	1 - 5	M6	650	100
57420805	1 - 5	M8	700	100
57421005	1 - 5	M10	720	100

## Mocowania kabli i przewodów

Britclips® PCD Klipsy wciskane dla przewodów płaskich i opasek

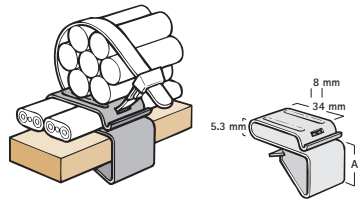

Nr kat.	A (mm)	Opak. (szt.)
52323412	3 - 12	100
52323425	12 - 25	100

Britclips® C ICC Klipsy do dźwigarów z uchwytem szczękowym

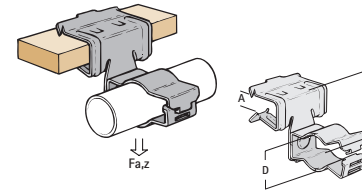

Nr kat.	A (mm)	D (mm)	H (mm)	Fa,z (N)	Opak. (szt.)
50122409	4 - 8	20 - 22	16	450	50
50122609	4 - 8	23 - 25	16	450	50
50122416	8 - 14	20 - 22	30	450	50
50122616	8 - 14	23 - 25	30	450	50
50123216	8 - 14	26 - 32	30	450	50
50122420	14 - 20	20 - 22	32	450	50
50122620	14 - 20	23 - 25	32	450	50
50123220	14 - 20	26 - 32	32	450	50

Britclips® TRC Klipsy do prętów gwintowanych

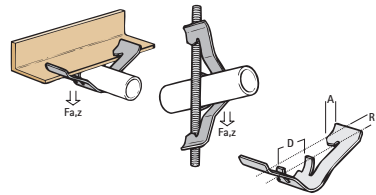

Nr kat.	Kod	A (mm)	D (mm)	R	Fa,z (N)	Opak. (szt.)
55922510	SC1000	6 - 9	16 - 20	M6-M8 / M10	450	100

## Mocowania ciężkie

BIS Klamry do dźwigarów model C

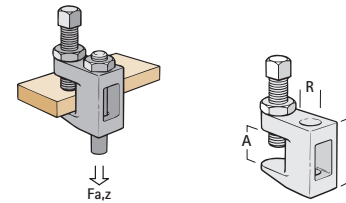

Nr kat.	A (mm)	R (mm)	G	H (mm)	Fa,z (N)	Opak. (szt.)
6003905	≤18	9	M8	35	1,200	50
6003910	≤20	11	M10	42	2,500	50
6003912	≤26	13	M10	54	3,500	50

# Mocowania do sufitów podwieszanych

## Britclips® Tiger Uniwersalne klipsy do dźwigarów

Nr kat.	Kod	A (mm)	B (mm)	H (mm)	Opak. (szt.)
51805208	Tiger 8	2-8	30	62	100
51803216	Tiger 16R	8-16	32	110	25
51804224	Tiger 24	16-24	48	110	50

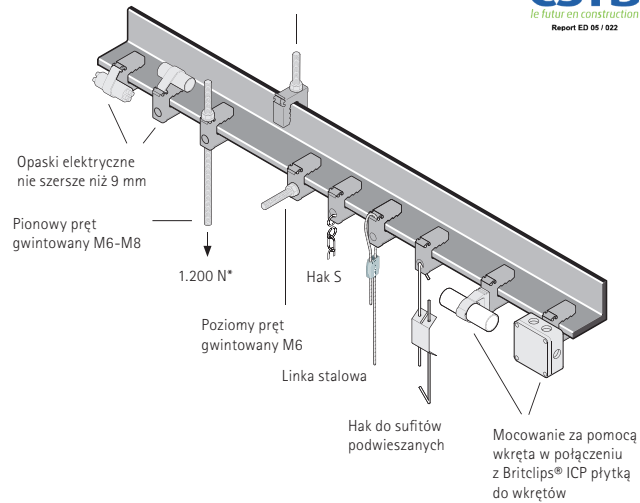
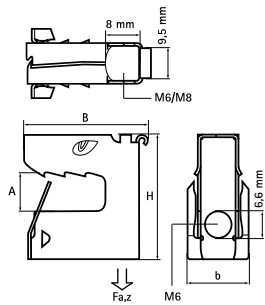

1. Otwór dla opasek kablowych (nie szerszych niż 9 mm, prętów gwintowanych M6-M8, linek stalowych itp.)
2. Otwór o średnicy 6,7 mm dla prętów gwintowanych M6, haków S, haków do sufitów podwieszanych, itp.
3. Britclips® ICP Płytkę dla wkrętów o średnicy 4,0 -4,5 mm

## Britclips® GAM8 Klipsy wciskane dla rurek i wiązek

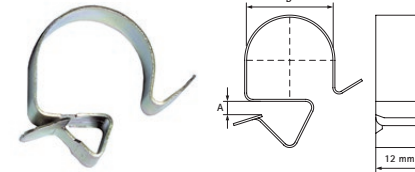

Nr kat.	Kod	D (mm)	A (mm)	Opak. (szt.)
52090709	GAM8 7 9	6-9	2-7	100
52090714	GAM8 7 14	10-14	2-7	100
52090721	GAM8 7 21	15-21	2-7	100
52090732	GAM8 7 32	22-32	2-7	100
52091209	GAM8 12 9	6-9	8-12	100
52091214	GAM8 12 14	10-14	8-12	100
52091221	GAM8 12 21	15-21	8-12	100
52091232	GAM8 12 32	22-32	8-12	100

## Britclips® ACT Wieszaki do sztydów

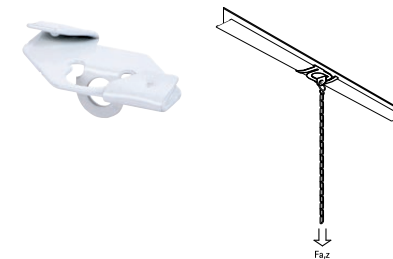

Nr kat.	Fa,z (N)	Opak. (szt.)
56091075	195	25

## Britclips® ACC15 Klipsy do sufitów podwieszanych z trzpieniem

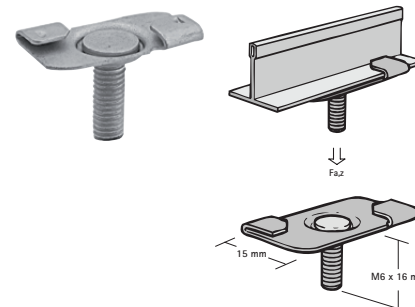

Nr kat.	Kod	Fa,z (N)	Opak. (szt.)
56521600	ACC15 M6x16	220	100

Britclips® TR CT Klipsy do prętów z uchwytem dla korytek

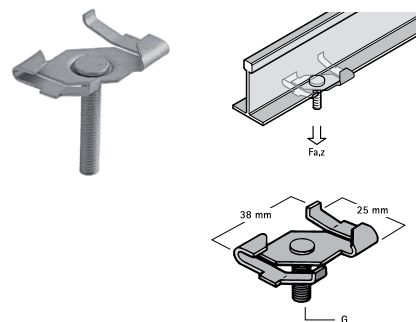

Nr kat.	Kod	G	Fa,z (N)	Opak. (szt.)
56521602	ACO M6x16	M6x16mm	220	100

BIS Yeti® 130

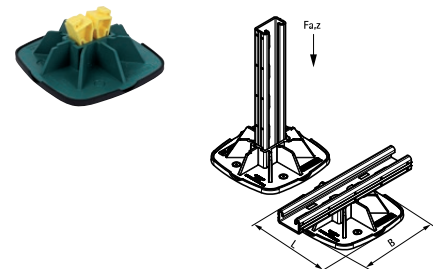

Nr kat.	Model	L (mm)	B (mm)	Dla szyn	Fa,z (N)	Opak. (szt.)
67685130	Z matą w komplecie	130	130	Strut 41x21	2 500	10

BIS Yeti® 280

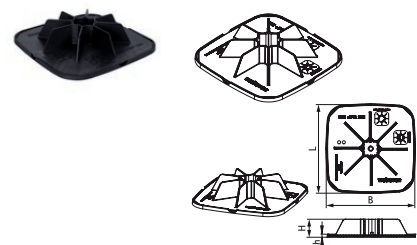

Nr kat.	Model	L (mm)	B (mm)	H (mm)	h (mm)	Fa,z (N)	Opak. (szt.)
67685280	Z matą w komplecie	284	284	58	8	12 500*	12

BIS Wieszaki do blach trapezowych

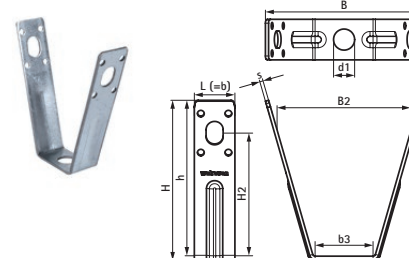

Nr kat.	Fa,z (N)	d1(mm)	Opak. (szt.)
6785101	1700	Ø 13,0	50

Britclips® RTB Wieszaki do blach trapezowych

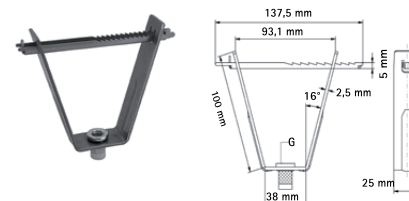

Nr kat.	Kod	G	Fa,z (N)	Opak. (szt.)
6781108	RTB 8	M8	1 500	50
6781110	RTB 10	M10	1 500	50

BIS Haki S

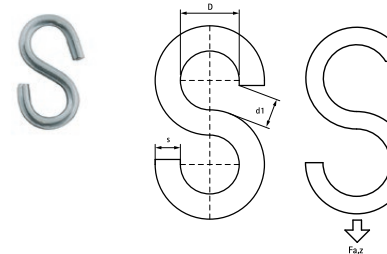

Nr kat.	D (mm)	s (mm)	d1 (mm)	Fa,z (N)	Opak. (szt.)
6941040	11,0	4,0	5,0	250	100

BIS Łańcuchy (DIN 5685)

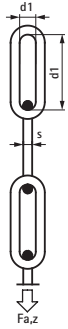

Nr kat.	L (m)	s (mm)	d1 (mm)	Fa,z (N)
0910015	30	3,0	26x5,4	600



BIS Łańcuchy węzłowe (DIN 5686)

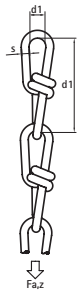

Nr kat.	L (m)	s (mm)	d1 (mm)	Fa,z (N)
0912022	30	2,0	28x5,0	400

BIS Pręty gwintowane

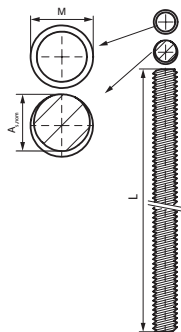

Nr kat.	Typ	Thread (M)	L (m)	As,nom (mm <sup>2</sup> )	Fa,z (N)	Wiązka mała
6303206	DIN 976-1	M6	2	20,1	5 300	50
6303208	DIN 976-1	M8	2	36,6	9 700	50
6303210	DIN 976-1	M10	2	58,0	15 400	50



BIS RapidStrut® Szyny montażowe (BUP1000)

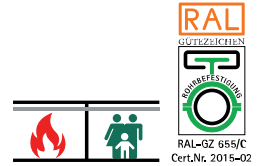

Nr kat.	L (m)	B (mm)	H (mm)	s (mm)	S (mm)	RAL	Wiązka mała	Wiązka duża	J.m.
65018622	6	41	21	2,00	22	RAL1	60	600	m.

BIS RapidStrut® Szyny montażowe



Nr kat.	Typ	L (m)	B (mm)	H (mm)	s (mm)	S (mm)	Wiązka mała	Wiązka duża	J.m.
650527183	27x18	3	27	18	1,00	15	30	600	m.
650530153	30x15	3	30	15	1,50	15	30	720	m.
650530203	30x20	3	30	20	1,25	15	30	720	m.

BIS RapidStrut® Kątowniki 90° G2 do szyn montażowych (BUP1000)

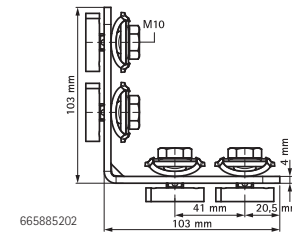

Nr kat.	Model	a (°)	Dla szyn	T(max) (Nm)	Opak. (szt.)
665885102	Krótki/Krótki	90	Strut	15	50
665885202	Krótki/Krótki	90	Strut	15	50
665885203	Krótki/długi	90	Strut	15	25
665885205	Długi/długi	90	Strut	15	25



BIS Zaślepki do szyn montażowych WM0-35



Nr kat.	Dla szyn	Kolor	Opak. (szt.)	Kart. (szt.)
6566000	WM0 (27x18mm) WM15 (30x20mm)	Zielony	50	250
6566001	WM1 (30x15mm)	Zielony	50	250
6566002	WM2 (30x30mm)	Zielony	25	250

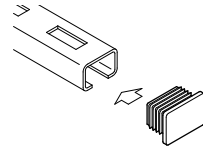

BIS Zaślepki do szyn montażowych Strut

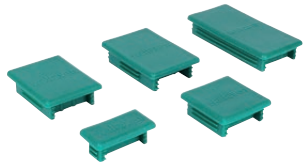

Nr kat.	Dla szyn	Opak. (szt.)	Kart. (szt.)
6566021	Strut 41x21	50	2 500
6566041	Strut 41x41	50	1 500

BIS Klamry do dźwigarów model C

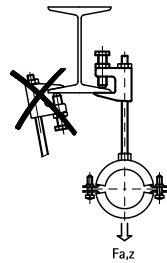
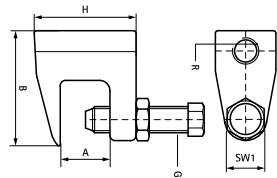

Nr kat.	Kod	A (m)	R	G	B (mm)	H (mm)	SW1 (mm)	Fa,z (N)	FM	VdS
6003208	TKN8-M8	≤18	M8	M8	38	35	13	1 200	-	VdS
6003010	TKN10-M10	≤20	M10	M10	44	42	17	2 500	FM	VdS

BIS Taśmy montażowe – stalowe

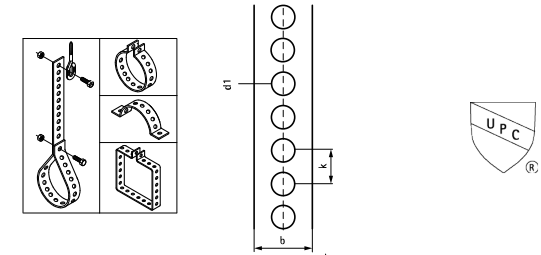

Nr kat.	Typ	L (m)	bxs (mm)	d1 (mm)	k (mm)	Fa,z (N)	Opak. (szt.)
0831012	5055L	10	12x0,8	5,0	8,0	840	10

WDI1R Kotwa wbijana zredukowana

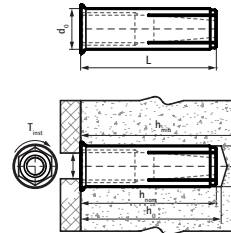

Nr kat.	Kod	Rek. obc. rozcz.**	Opak. (szt.)
6103206	WDI1R 6x25	1,67*	100
6103208	WDI1R 8x25	1,90*	100
6103210	WDI1R 10x25	2,14*	50
6103212	WDI1R 12x25	2,14*	50

\*Rek. obciążenie: do betonu spękanego i niespękanego wg ETAG001, Part 6; odnoszą się do prawidłowo zainstalowanych kotew przy max. głębokości osadzenia; uwzględnia częściowy wsp. bezpieczeństwa i ogólny cz.wsp. bezpieczeństwa 1.4.  
\*\* Rekomendowane obciąż. rozciąg.



W-LX-N Śruby do betonu

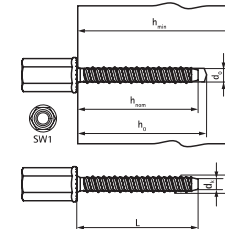

Nr kat.	Kod	Rek. obc. rozcz.**	Opak. (szt.)
62433304	W-LX-N 6x35	1,42*	100
62433305	W-LX-N 6x55	1,42/2,85/4,28*	100

\*Rek. obciążenie: do betonu spękanego i niespękanego wg ETAG001, Part 6; odnoszą się do prawidłowo zainstalowanych kotew przy max. głębokości osadzenia; uwzględnia częściowy wsp. bezpieczeństwa i ogólny cz.wsp. bezpieczeństwa 1.4.  
\*\* Rekomendowane obciąż. rozciąg.



WDI1 Kotwa wbijana

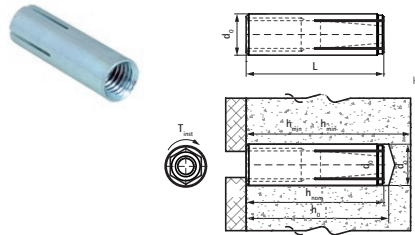

Nr kat.	Kod	L (mm)	Rek. obc. rozc.*	Opak. (szt.)
6103006	WDI1 6x25	25	0,52*	100
6103008	WDI1 8x30	30	1,02*	100
6103010	WDI1 10x40	40	1,55*	50
6103012	WDI1 12x50	50	2,19*	50
6103016	WDI1 16x65	65	4,53*	25

\*Rek. obciążenie: do betonu spękanego i niespękanego wg ETAG001, Part 6; odnoszą się do prawidłowo zainstalowanych kotew przy max. głębokości osadzenia; uwzględnia częściowy wsp. bezpieczeństwa i ogólny cz.wsp. bezpieczeństwa 1.4.  
\*\* Rekomendowane obciąż. rozciąg.

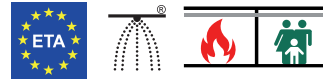

WDI1L Kotwa wbijana z kołnierzem

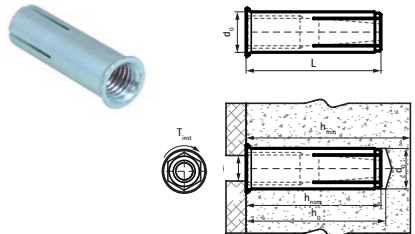

Nr kat.	Kod	L (mm)	Rek. obc. rozc.*	Opak. (szt.)
6103106	WDI1 6x25	25	0,52*	100
6103108	WDI1 8x30	30	1,02*	100
6103110	WDI1 10x40	40	1,55*	50
6103112	WDI1 12x50	50	2,19*	50
6103116	WDI1 16x65	65	4,53*	25

\*Rek. obciążenie: do betonu spękanego i niespękanego wg ETAG001, Part 6; odnoszą się do prawidłowo zainstalowanych kotew przy max. głębokości osadzenia; uwzględnia częściowy wsp. bezpieczeństwa i ogólny cz.wsp. bezpieczeństwa 1.4.  
\*\* Rekomendowane obciąż. rozciąg.

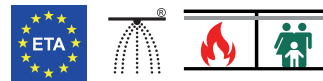

WDI1R Zestaw do osadzania kotew zredukowanych



Nr kat.	Kod	LU (mm)	d <sub>o</sub> (mm)	Dłg
6902206	WDI1R STS 6	25	8	WDI1R M6
6902208	WDI1R STS 8	25	10	WDI1R M8
6902210	WDI1R STS 10	25	12	WDI1R M10

WIS Kotwa chemiczna WVSF200



Nr kat.	Kod	ETA	LEED	WRAS	VOC+	Seismic	Poj.
6099123E	WVSF200	ETA	LEED	WRAS	VOC+	C1	300 ml

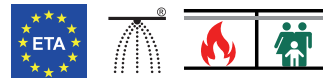

# Britclips® RSWB Uniwersalna szyna ścienna



## Zalety & właściwości

- szyna o regulowanej szerokości do mocowania rur, przewodów, kabli
- odpowiednia do użycia w konstrukcjach z płyt gipsowo-kartonowych oraz legarach podłogowych
- może być mocowana do drewna lub elementów metalowych
- szybsza i prostsza instalacja w odniesieniu do tradycyjnych metod
- może być montowana na różnej głębokości
- kompatybilna z nakrętką ślizgową RapidRail®, obejmą, uniwersalnym adapterem szynowym oraz śrubami młotkowymi BIS StarQuick®
- produkt o nr kat. 59491016: krótsza wersja o zakresie 25 - 40 cm
- rozszerza się od 16 - 24" (40 - 60 cm)
- materiał: stal
- ocynkowane metodą Sendzimira

Nr kat.	Model
59491016	10-16"
59491624	16-24"

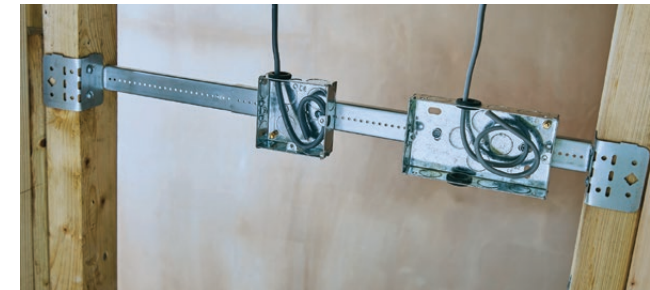

## Opinie naszych klientów:

„Szyna RSWB szybko stała się podstawowym elementem dla naszych mocowań”

„Ten produkt oszczędza dużo czasu podczas montażu”

„Taki prosty i łatwy w użyciu”

„Po prostu rewelacja”



## Polska

Lietuva - Latvija - Eesti

### Walraven Sp. z o.o.

ul. Isep 3

31-588 Kraków (PL)

Tel. +48 (0)12 684 00 95

Fax +48 (0)12 684 28 01

info.pl@walraven.com

## Walraven Group

Mijdrecht (NL) · Tienen (BE) · Bayreuth (DE)

Banbury (GB) · Malmö (SE) · Grenoble (FR)

Barcelona (ES) · Kraków (PL) · Mladá Boleslav (CZ)

Moscow (RU) · Kyiv (UA) · Danville (US)

Shanghai (CN) · Dubai (AE) · Budapest (HU)

Mumbai (IN) · Singapore (SG) · Burlington (CA)