

Saves up to 40%
fixing time



BIS RapidStrut®

Medium Rail System



BIS RapidStrut®



⊕ For all medium rail applications

Extensive system ⊕

⊕ Fast and easy fixing

Inspired by smart solutions from the start

Walraven is a globally active company in the installation industry, founded in 1942. We have always been dedicated to make the work of our customers easier and more effective. With simple and smart solutions, comprehensive services and excellent support.

Walraven. The value of smart



BIS RapidStrut®: For all medium rail applications



Insert, turn 1/4 stroke, slide and lock!



Fast and easy

The accessories are pre-assembled and delivered 'ready to use' on site. The plastic spring allows the slide nut to be fixed easily into the rail, retaining the assembly in place before final tightening.

Extensive system

The BIS RapidStrut® fixing system offers an extensive choice for rail profiles and cantilever arms. A broad range of accessories are also available.

BIS RapidStrut® Fixing Rail DS 5

The DS 5 has a unique design allowing BIS RapidStrut® Accessories to be mounted quickly on both sides of the rail.

For indoor and outdoor use

Extreme corrosion resistance. For more information about the BIS UltraProtect® 1000 System, see page 10-11.



Fixing rail and cantilever arms

Complete range of fixing rail



BIS RapidStrut® Fixing Rail (BIS UltraProtect® 1000)



L (m)	41 x 21* 2.5 mm	41 x 41* 2.0 mm	41 x 41* 2.5 mm	41 x 51 2.0 mm	41 x 62 2.5 mm	41 x 82 2.5 mm
2	65018227	65018242	65018247	65058252	-	-
3	65018327	65018342	65018347	65058352	65018367	-
6	65018627	65018642	65018647	65058652	65018667	65018687



BIS RapidStrut® Fixing Rail (pre-galvanized)

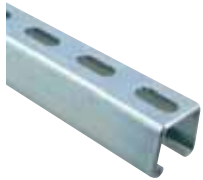

L (m)	41 x 21* 1.5 mm	41 x 21* 2.0 mm	41 x 21* 2.5 mm	41 x 41* 1.5 mm	41 x 41* 2.0 mm	41 x 41* 2.5 mm	41 x 62 2.5 mm	41 x 82 2.5 mm
2	6505224	6505222	6505225	6505244	6505242	6505245	-	-
3	6505324	6505322	6505325	6505344	6505342	6505345	6505365	6505385
6	6505624	6505622	6505625	6505644	6505642	6505645	6505665	6505685

* = RAL. Also available in stainless steel. Ask for the possibilities!

BIS RapidStrut® Fixing Rail Double (pre-galvanized)

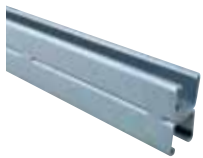

L (m)	41 x 21D 2.5 mm	41 x 41D 2.5 mm	41 x 62D 2.5 mm	41 x 82D 2.5 mm
6	6505626	6505646	6505666	6505686

Also available in hot dip galvanized.

BIS RapidStrut® Wall Plate



Part No.	For Strut
665885400	21, 41, 62, 82

BIS RapidStrut® Cantilever Arms

L (mm)	Strut 41 x 21 x 2.0 vertical	Strut 41 x 21 x 2.5	Strut 41 x 41 x 2.5 with support	Strut 41 x 41 x 2.0	Strut 41 x 41 x 2.5	Strut 41 x 41D 2.5
150	-	-	-	-	6603861	-
200	-	6603831	-	-	6603870	-
300	6603828	6603832	-	6603923	6603862	-
450	-	6603833	-	6603926	6603863	6603883
600	6603829	6603834	6601894	6603928	6603864	6603884
750	-	-	-	-	6603865	6603885
1000	-	-	-	-	6603866	6603886
1200	-	-	-	-	6603867	-

Other sizes on request.



6603828



6603831



6601894

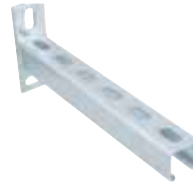

6603923 / 6603861



6603883

Accessories for BIS RapidStrut®

For rail construction

BIS Rail Junction Angle Bracket



Part No.

65938020

BIS Strut Angle Bracket



Part No.

66038020

BIS Rail Prop



Part No.

66288530

BIS RapidStrut® Accessories G2

For pipe fixing & rail construction



Features and benefits

- Quick and easy fixing to the rail
- Pre-assembled 'ready-to-use'
- Suitable for all Strut profiles
- Saves up to 40% fixing time!
- *Direct Twist* technology for easy and secure installation
- Visual guide to check the position of the slide nut
- Optimised for easy installation with electrical tools
- BIS UltraProtect® 1000 protection for indoor and outdoor use

BIS RapidStrut® Hammerfix G2



Part No.	G	L (mm)	LU (mm)
652785804	M8	40	16
652785805	M8	50	26
652785806	M8	60	36
652785808	M8	80	56
652785810	M8	100	76
652785004	M10	40	12
652785006	M10	60	32
652785008	M10	80	52
652785204	M12	40	10
652785206	M12	60	30

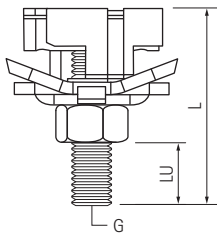

BIS RapidStrut® Slide Nuts G2



Part No.	Type
665185106	M6
665185108	M8
665185110	M10
665185112	M12



Unless mentioned otherwise:
all BIS RapidStrut® accessories on this page
are protected by BIS UltraProtect® 1000.

BIS RapidStrut® Hammerfix 'U' G2

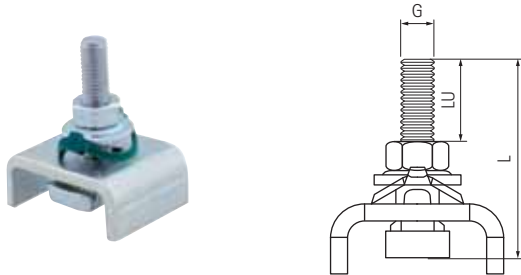

Part No.	Type	L (mm)	LU (mm)
665285006	M10	60	30

BIS RapidStrut® Slide Nuts Plastic Tabs

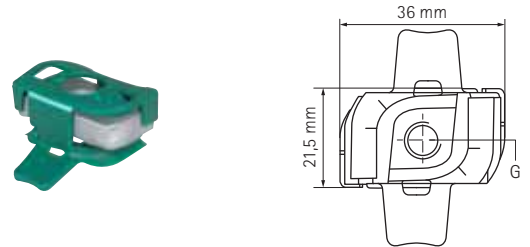

Part No.	G
651868008	M8
651868010	M10
651868012	M12

BIS RapidStrut® Rail Connectors G2

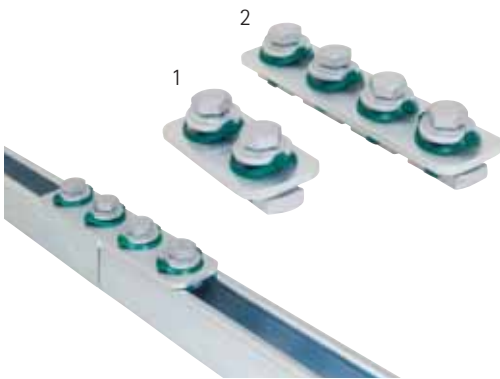

Part No.	
1	665885184
2	665885186

BIS RapidStrut® Rail Connector (U-shaped) G2

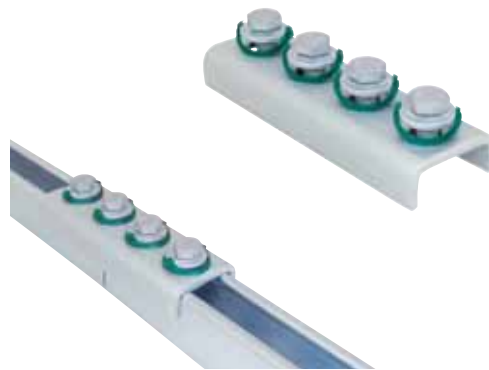

Part No.	
	665885421

BIS RapidStrut® Rail T- and X-Connector G2

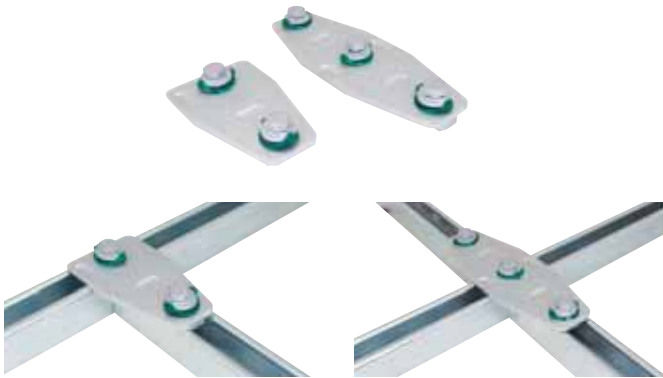

Part No.	Type
665885213	T
665885223	X

BIS RapidStrut® Cross Connectors G2

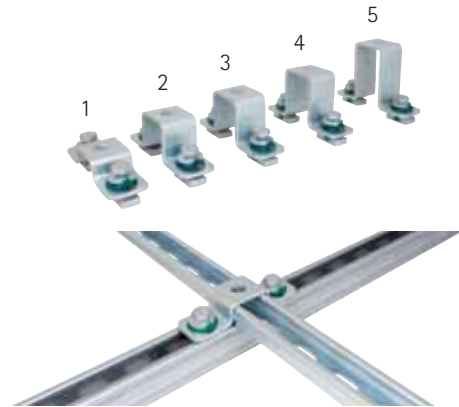

Part No.	For
1	665885402 Strut 41 x 21
2	665885404 Strut 41 x 41
3	665885405 Strut 41 x 51
4	665885406 Strut 41 x 62
5	665885408 Strut 41 x 82

BIS RapidStrut® Rail Connectors 90° G2

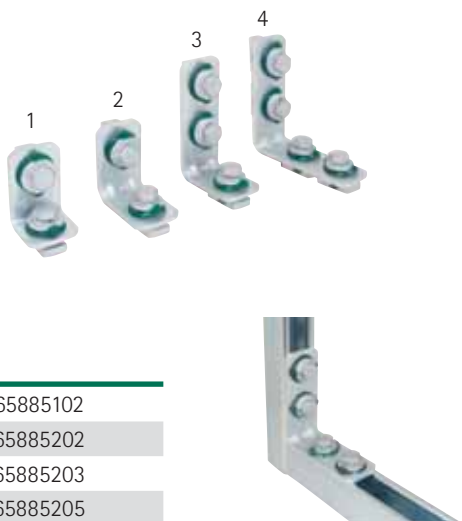

Part No.	
1	665885102
2	665885202
3	665885203
4	665885205

BIS RapidStrut® Rail Connectors 135° G2

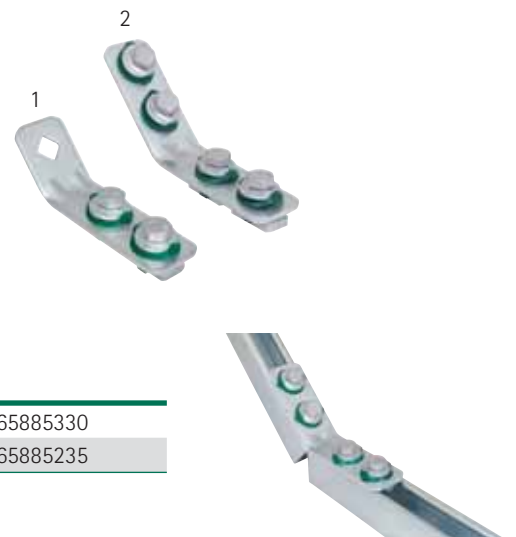

Part No.	
1	665885330
2	665885235

Accessories for BIS RapidStrut®

For rail construction and finishing

BIS RapidStrut® Rail End Caps



Part No.	For
6566021	Strut 41 x 21
6566041	Strut 41 x 41
6566051	Strut 41 x 51

Material: PE (polyethylene), green

BIS RapidStrut® PVC Profile

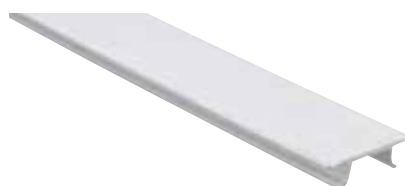

Part No.
6566999

Material: PVC (polyvinylchloride), white

BIS RapidStrut® Rubber Strips

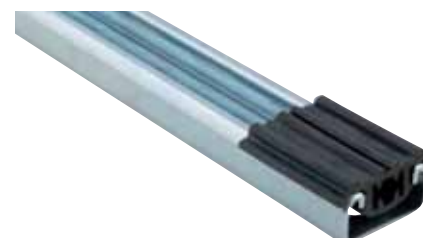

Part No.	L
6568041	30 m
6568042	50 mm

Material: EPDM rubber, black



Unless mentioned otherwise:
all BIS RapidStrut® accessories on this page
are protected by BIS UltraProtect® 1000.

BIS UltraProtect® 1000

For indoor and outdoor use

- Unique system, composition and corrosion resistance
- For fixing or supporting mechanical installations, solar systems and more

Optimal protection

- All applied surface treatments effortlessly withstand a salt spray test of at least 1000 hours*
- Suitable for corrosive environments (C1–C4 in accordance with ISO 12944-2)



Better than hot dip galvanizing

- Higher corrosion resistance: 1000 hours* versus 300 - 600 hours (with a layer thickness of 50 - 80 µm)
- Threaded products are also well protected
- Products feel smooth and are also visually appealing



Complementary system

- The products in the BIS UltraProtect® 1000 system combine together perfectly
- Can also be combined with zinc plated, pre-galvanized or hot dip galvanized products**



* Until the occurrence of maximum 5% red rust.

** The warranty terms can be found on our website walraven.com.



The proof after 1000 hours salt spray test

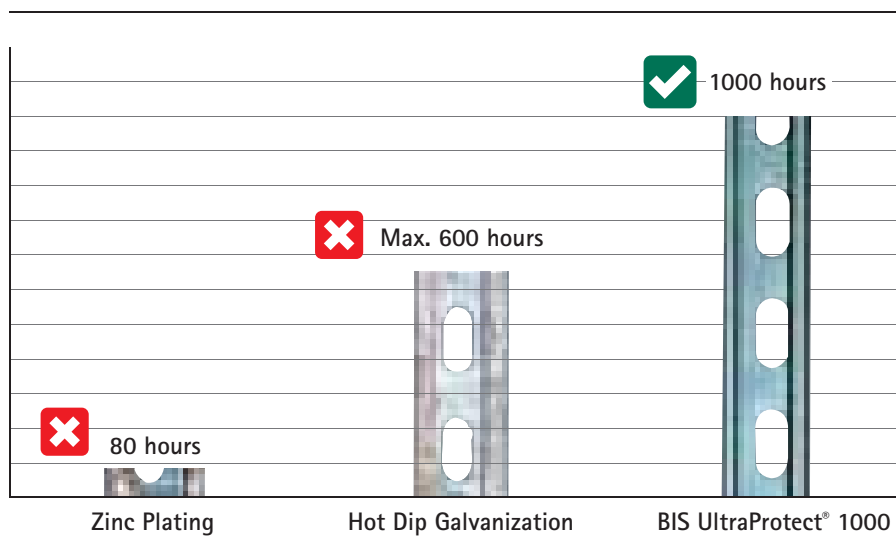

More accessories and stainless steel

A selection from the range

Besides our unique BIS RapidStrut® Fixing System we offer a wide range of accessories for safe constructions. Below just a selection

of our comprehensive range. For a complete overview please visit the Strut section in our web catalogue at walraven.com.



■ BIS Strut T-Bracket



■ BIS Strut Z-Bracket



■ BIS Strut
T-Base Plate



■ BIS Strut Rail
Beam Clamp



■ BIS Strut Wall Plate
Hinged



■ BIS Threaded Rod



■ BIS Strut Floor
Bracket



■ BIS Strut U-Connector
linear



■ BIS Strut Slide Nut



■ BIS Strut U-Washer



■ BIS Strut Connector



■ BIS Strut Wall Plate



■ BIS Strut Connector
90°

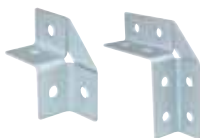

■ BIS Strut Connector
90°



■ BIS Strut Cross
Connector



■ BIS Strut Angle
Connector 135°



■ BIS RapidStrut®
Slide Nut MS

The right combination

BIS Heavy Duty Clamps

Due to its robust design and solid locking the BIS Heavy Duty Clamps are perfectly equipped for fixing heavier pipes. The range includes a clamp for each common pipe size. The locking nut is captive, hidden in a plastic nut holder. Moreover the locking screws are provided with anti-loss washers. No more time wasted with incomplete clamps!

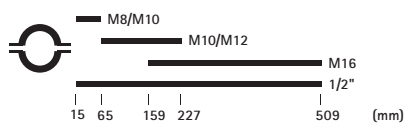
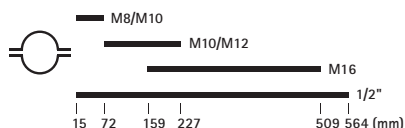

starQuick® Universal Rail Adaptor

Adaptor for fixing starQuick® Clamps to BIS RapidRail® or Strut Rail. To add pipework quickly and simply to an existing installation. Suitable for starQuick® Clamps 10 to 55 mm. Suitable for BIS RapidRail® WMO, 1, 15, 2, 30, 35 + Strut.

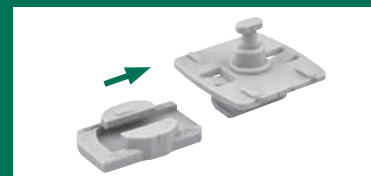

BIS Yeti®

Features and benefits

- For supporting climate installations, solar panels, walkways, etc. on flat roofs
- Adjustable to suit numerous applications
- With non-slip anti-vibration mat for improved installation weight distribution
- A foundation for a solid and reliable installation
- Innovative and multifunctional



■ BIS Yeti® 480



■ BIS Yeti® 335



■ BIS Yeti® 130

BIS PushStrut

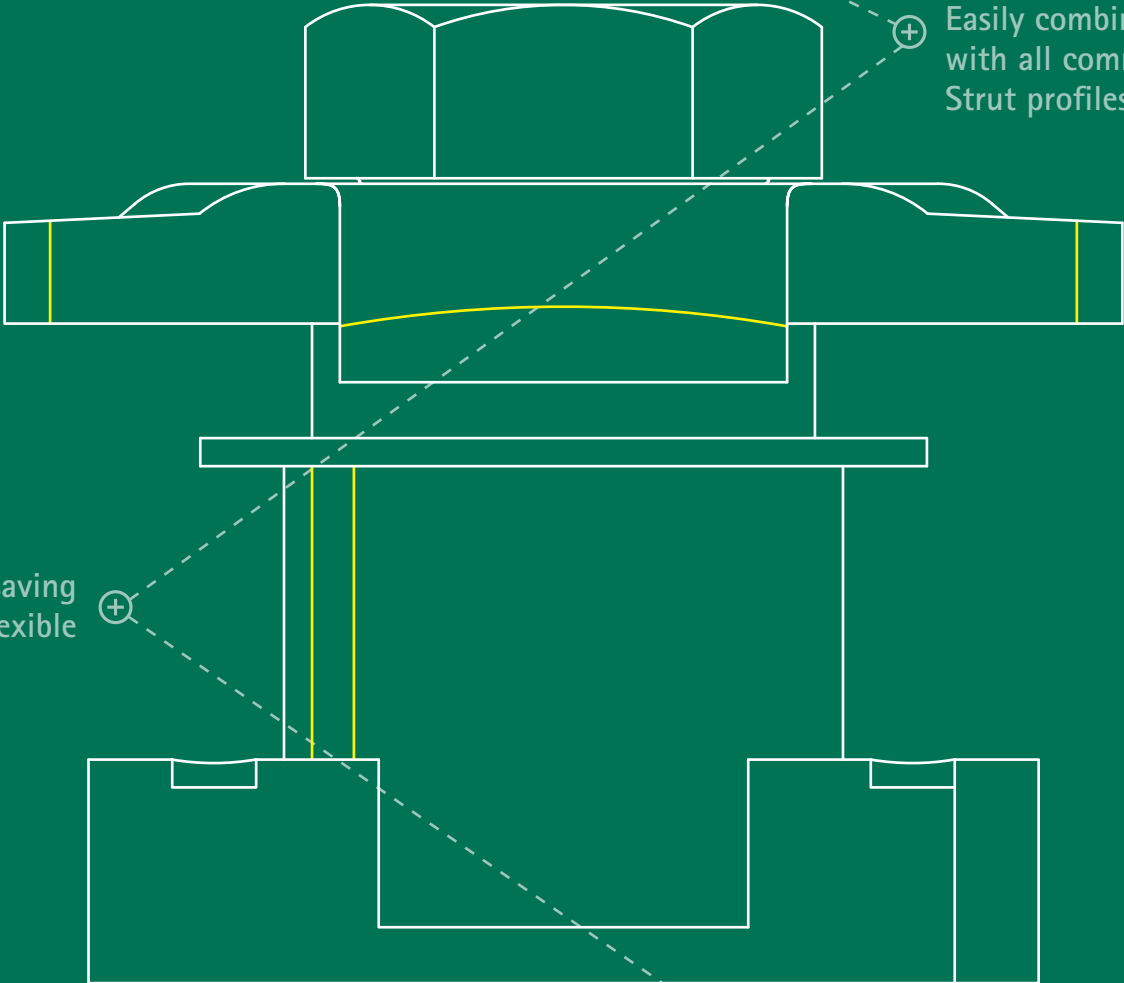

+ Easily combined with all common Strut profiles

+ Timesaving and flexible

+ For easy installation of complex rail constructions

BIS PushStrut

The quick and safe way to connect



New Strut range

- Timesaving and flexible
- For easy installation of complex rail constructions
- Less parts to do your job
- Products always fit together

BIS PushStrut Button



66519910

- Universal button: easily combined with all common Strut profiles and all BIS PushStrut Connectors
- Teeth with force fit connections offer more stability
- Max. allowed load (Fa,z) 5,000 N, shear load 3,000 N*

* The max. allowed load (Fa,z) refers to rails and cantilever arms with a material thickness of 2.5 mm. The Fa,z at a thickness of 2.0 mm profile thickness = 4,500 N. The Fa,z at a thickness of 1.5 mm profile thickness = 3,500 N.

Assembly instruction

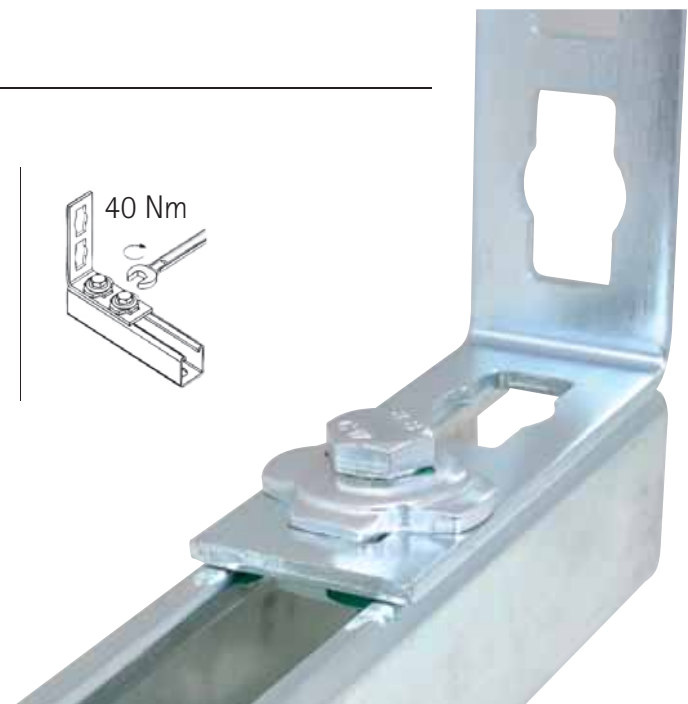
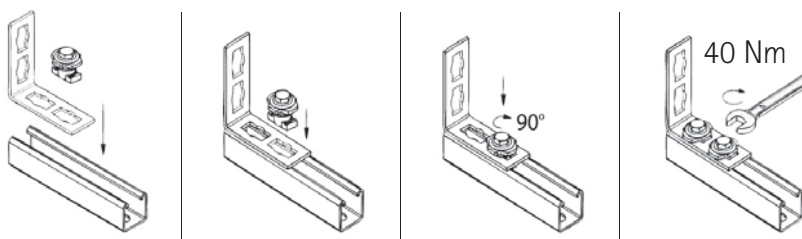



Customer support

Whatever your needs, Walraven can provide a solution. Our product and sales experts are ready to help, and have up-to-date local knowledge and expertise. Want to know more about how we can support you? Get in touch today!

walraven.com

BIS PushStrut

Easily combined with all common Strut profiles

**BIS PushStrut
Connector Flat 90°/135°**

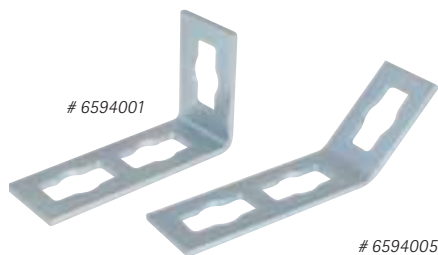

- Flexible use of hole pattern
- Quick and easy to install

BIS PushStrut Wall Plate

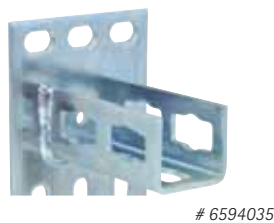

- Stable connection of rails to floor, ceiling or wall
- Timesaving and flexible

**BIS PushStrut
Connector Angle Bracket**

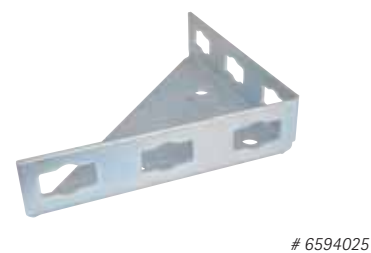

- Stable rail connection due to fixing to the building

**BIS PushStrut
Connector 90° 2-2**

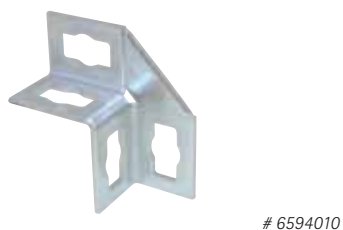

- Lateral edges offer great stability
- Flexible use of hole pattern

**BIS PushStrut
Connector 90° 4-4**

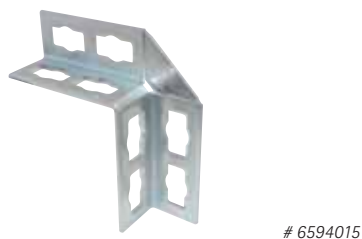

- Lateral edges offer great stability
- Flexible use of hole pattern

**BIS PushStrut
Connector T**

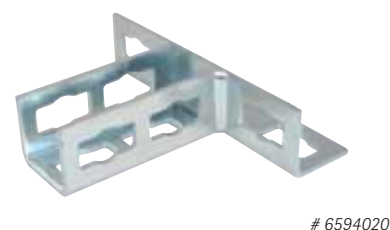

- Stable T-connection due to lateral edges
- Flexible use of hole pattern

BIS PushStrut

Easily combined with all common Strut profiles

BIS PushStrut
3D Connector 6-3-3-L

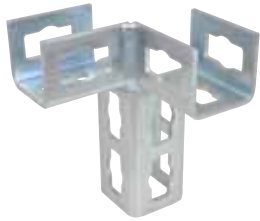

6594030

BIS PushStrut
3D Connector 6-3-3-R

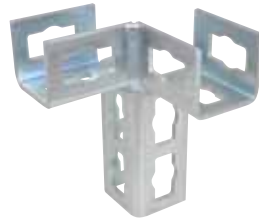

6594031

BIS PushStrut
3D Connector 6-6-3-3

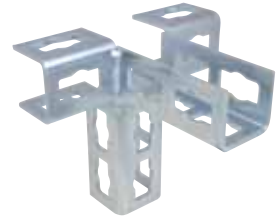

6594032

- 3D-Connector for complex frame and rail constructions
- Universal and simple use
- Easy to remove and reusable

*Stable connection of rails
to floor, ceiling or wall*

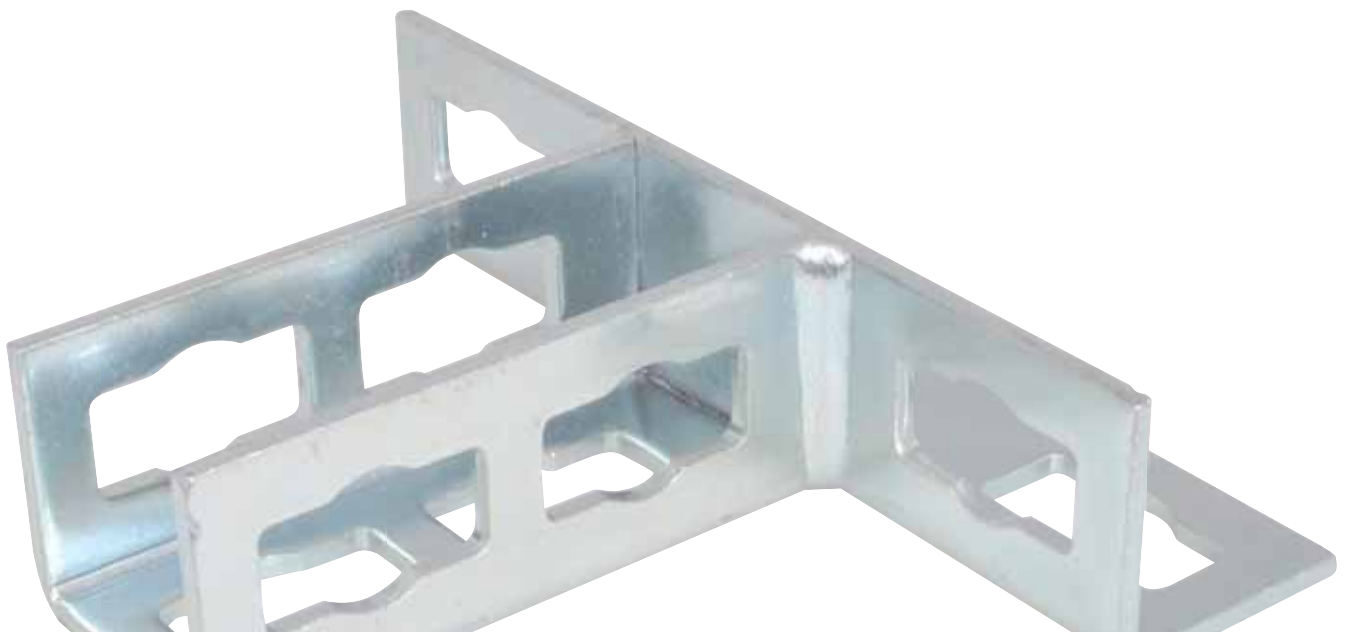

Technical Advisory Service

From the experts at Walraven

At Walraven, our service does not end after you have purchased your products. We pride ourselves on our invaluable after sales support and technical advice.

Based on your individual requirements our Technical Support staff will deliver you a well grounded proposal with detailed calculations, AutoCAD drawings and parts lists.

Our expertise is available for you!
For more information visit walraven.com.

*From engineering to
on-site construction
support*

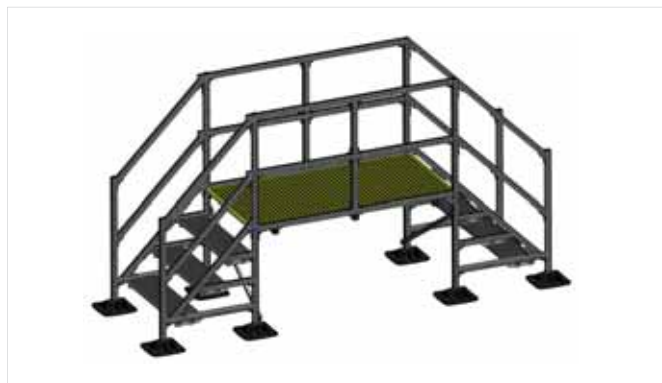

Find out how we can support you

Would you like to find out more about any of the solutions described in this brochure?

Or would you like to discuss how we could help you find the best possible solution for your project? Get in touch today!

Singapore

South East Asia & Pacific

Walraven Pte. Ltd.

71 Lorong 23 Geylang #06-14
388386 Singapore (SG)
customerservice.sg@walraven.com

Other countries

Walraven International

Industrieweg 5
3641 RK Mijdrecht (NL)
Tel. +31 297 23 30 00
Fax +31 297 23 30 99
export@walraven.com

Walraven Group

Mijdrecht (NL) · Tienen (BE) · Bayreuth (DE) · Banbury (GB) · Malmö (SE) · Grenoble (FR) · Barcelona (ES) · Kraków (PL)
Mladá Boleslav (CZ) · Moscow (RU) · Kyiv (UA) · Detroit (US) · Shanghai (CN) · Dubai (AE) · Budapest (HU) · Mumbai (IN)
Singapore (SG)

