

Designet til plastrør



## BIS Bifix<sup>®</sup> 5000 G2

Den næste generation



BIS Bifix® 5000 G2



Den næste generation



Komfortabel  
& sikker at  
installere



Unikt design  
til plastrør



Avanceret  
geometri



Optimal beskyttelse med  
BIS UltraProtect® 1000

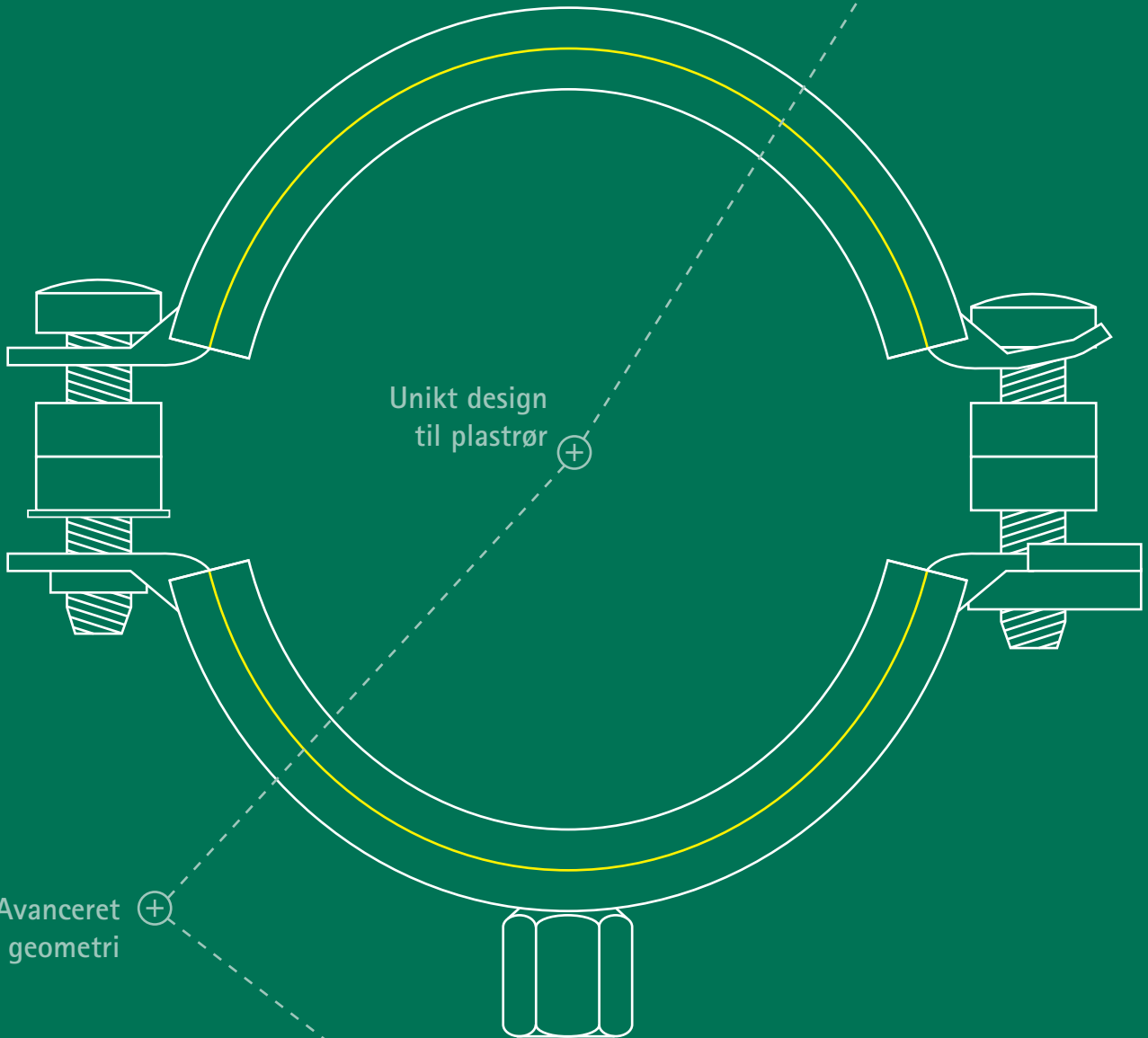

# BIS Bifix<sup>®</sup> 5000 G2

Den næste generation

## BIS Bifix<sup>®</sup> 5000 G2 Rørbøjle

- Til inden- & udendørs brug
- Øget styrke
- Til glidende & stram fiksering
- Til plastrør Ø 16 - 200 mm

# BIS Bifix<sup>®</sup> 5000 G2

Unikt design til plastrør



## Til glidende & stram fiksering

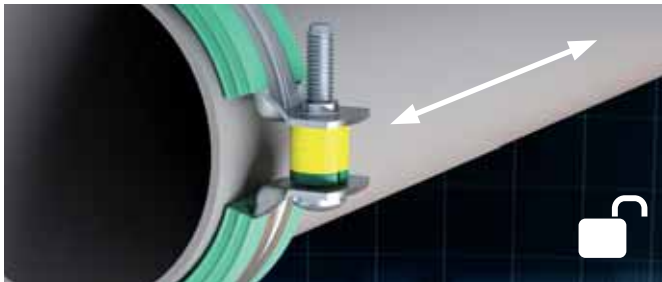

- Med afstandsskiver til ekspanderende rør

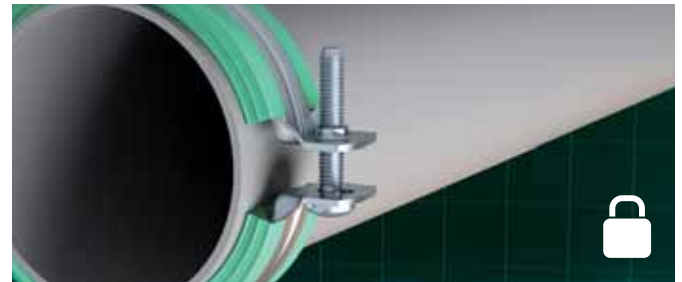

- Uden afstandsskiver som fikspunkt

## Øget styrke

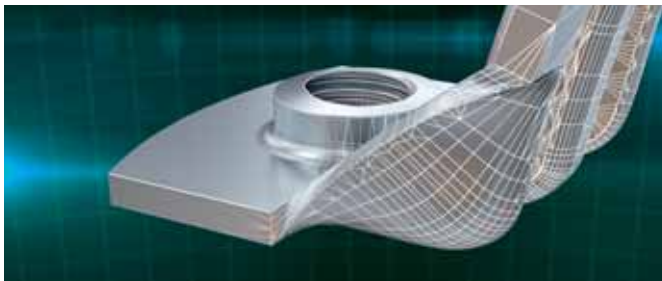

- Avanceret geometri; Bukkede kanter ved rørbøjens afslutning



- Ekstrem korrosionsbestandighed, unik indenfor HVAC

## Komfortabel & sikker at installere

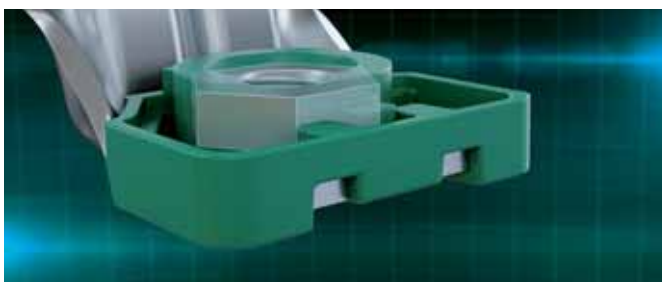

- Låst møtrik som sikring

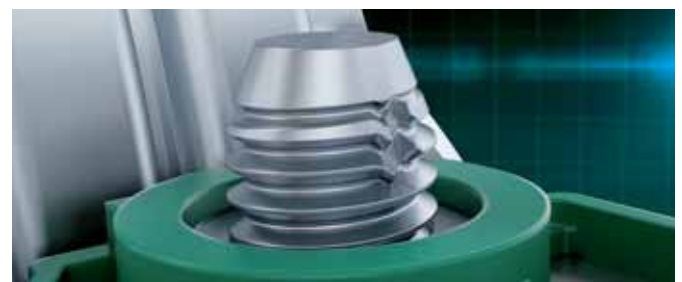

- Sikring mod tab af skrue



- Innovativ lås; Sammenlåsende system for øget sikkerhed



- Støjreducerende gummi foring

# Til plastrør

Ø 16 - 200 mm

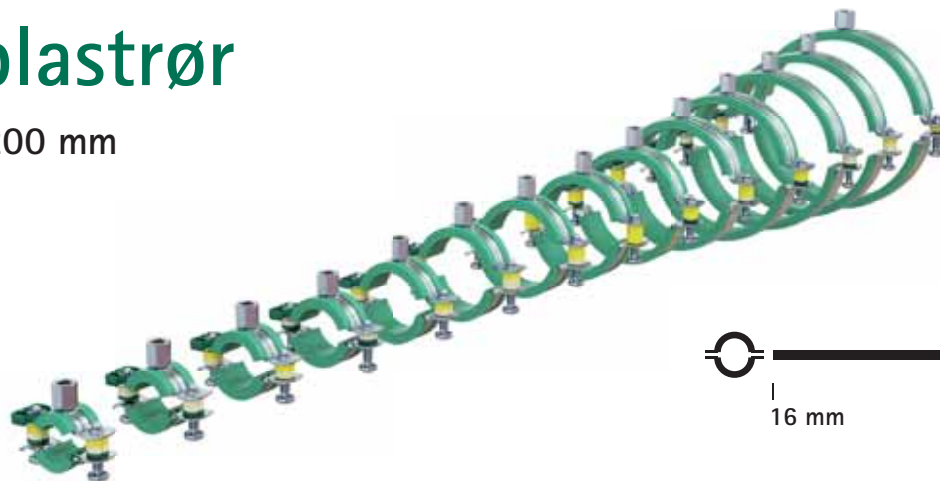

## Teknisk data

Rør Ø D (mm)	b x s (mm)	Gevindmuffe (G)	
		M8/M10	
16	20 x 1.25		318 8 016
20	20 x 1.25		318 8 020
25	20 x 1.25		318 8 025
32	20 x 1.25		318 8 032
40	20 x 1.25		318 8 040
50	20 x 1.25		318 8 050
56	20 x 1.25		318 8 056
58	20 x 1.25		318 8 058
63	20 x 1.25		318 8 063
75	20 x 1.25		318 8 075
78	20 x 1.50		318 8 078
90	23 x 2.00		318 8 090
110	23 x 2.00		318 8 110
125	23 x 2.00		318 8 125
135	23 x 2.00		318 8 135
160	25 x 2.50		318 8 160
200	25 x 2.50		318 8 200

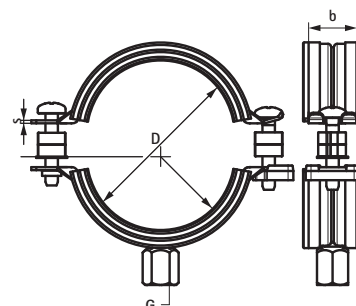

## Funktioner & fordele

- To-Skrue rørbøjle
- Med hurtigt låsesystem
- Med aftagelige afstandsskiver, som gør rørbøjlen passende til både fiksering & ekspanderende rør
- Overfladebeskyttelse: Produktet er en del af BIS UltraProtect® 1000 systemet
- Støjreducerende foring iht. DIN 4109
- Aldersresistent grøn EPDM gummi, specifikt til anvendelse med plastrør
- Indvendig del af gummien er glat, for at forbedre den glidende effekt af røret i rørbøjlen



# BIS UltraProtect® 1000

## Korrosionsbestandighed

- C1 - C4 / ISO 12944-2

## Saltspray test

- 1000 timer / ISO 9227

## Complementary system

- Perfect combination with other products

## Find ud af hvordan vi kan hjælpe

Vil du gerne vide mere om de mulige løsninger der er beskevet i denne brochure? Eller vil du gerne drøfte, hvordan vi kan hjælpe med at finde den bedste løsning til dit projekt? Så kontakt os i dag!

### Nordic

---

**Walraven Nordic AB**  
Nordenskiöldsgatan 6  
211 19 Malmö (SE)  
Tel. +46 (0)40 36 54 20  
info.se@walraven.com  
Tel. +45 46 37 05 10  
info.dk@walraven.com

### Walraven Group

---

Mijdrecht (NL) · Tienen (BE) · Bayreuth (DE) · Banbury (GB) · Malmö (SE) · Grenoble (FR) · Barcelona (ES) · Kraków (PL)  
Mladá Boleslav (CZ) · Moscow (RU) · Kyiv (UA) · Detroit (US) · Shanghai (CN) · Dubai (AE) · Budapest (HU)