

A unique clamp with  
quick locking system



## BIS Aero<sup>®</sup>

Spiral duct clamps



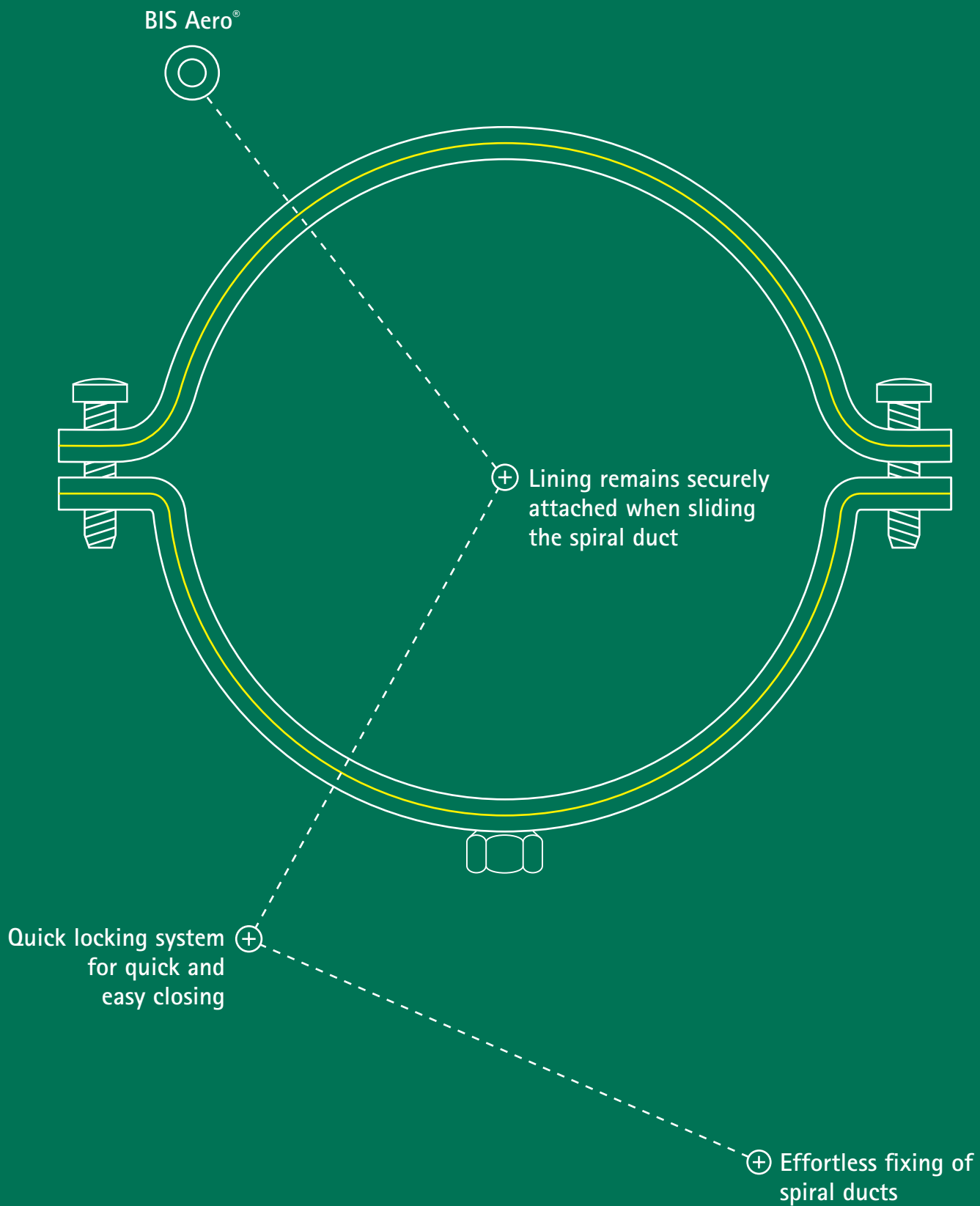

## Inspired by smart solutions from the start

Walraven is a globally active company in the installation industry, founded in 1942. We have always been dedicated to make the work of our customers easier and more effective. With simple and smart solutions, comprehensive services and excellent support.

Walraven. The value of smart

# BIS Aero®

The BIS Aero® is a unique clamp. The rubber lining is formed around and through the steel band. It is conjoined with the steel and stays attached when sliding the spiral duct through the clamp.

The newly designed and patented quick locking system enables safe and easy fixing of spiral ducts. The range covers all common spiral duct sizes from 80 up to and including 1.250 mm.



Rubber lining is conjoined with the clamp

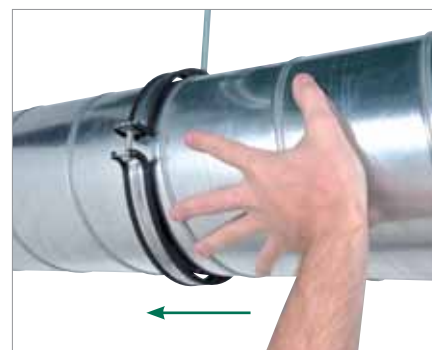

Trouble free sliding of spiral duct

## Patented quick locking system

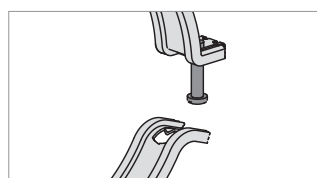

1.

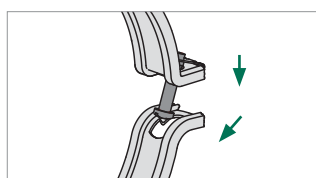

2.

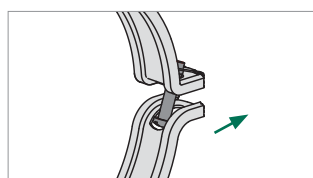

3.

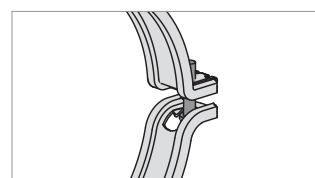

4.

$D \geq 450$ : locking 2 hexagon head bolts with nut.

## Technical data

- Pipe clamp made of steel, pre-galvanized
- Noise insulating lining made of TPE rubber, black

Part No.	G	D (mm)	B (mm)	H (mm)	Box (pc)
411 5 080	M8	80	134	84	25
411 5 100	M8	100	155	115	25
411 5 125	M8	125	179	139	20
411 5 140	M8	140	197	162	20
411 5 150	M8	150	205	164	20
411 5 160	M8	160	215	175	20
411 5 180	M8	180	238	202	20
411 5 200	M8	200	255	215	20
411 5 225	M8	225	280	246	20
411 5 250	M8	250	306	265	20
411 5 280	M8	280	336	302	25
411 5 300	M8	300	356	322	25
411 5 315	M8	315	371	332	25
411 5 355	M8	355	411	371	25
411 5 400	M8	400	456	416	20

$D \leq 400$  mm: patented quick locking system.

Part No.	G	D (mm)	B (mm)	H (mm)	Box (pc)
411 5 450	M8/M10	450	524	481	3
411 5 500	M8/M10	500	574	531	3
411 5 560	M8/M10	560	634	591	3
411 5 600	M8/M10	600	674	632	3
411 5 630	M8/M10	630	705	669	3
411 5 710	-	710	732	732	3
411 5 800	-	800	875	817	3
411 5 900	-	900	975	917	3
411 5 999	-	1.000	1.076	1.018	3
411 5 997	-	1.120	1.196	1.138	3
411 5 998	-	1.250	1.326	1.268	3

$D \geq 450$  mm: locking 2 hexagon head bolts with nut.

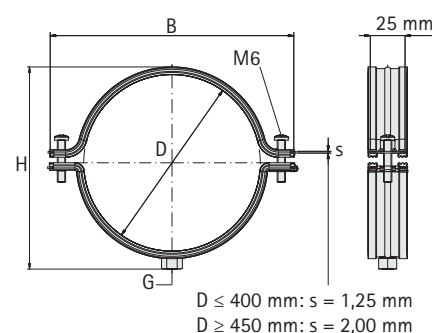

	D: 80 - 125 mm = $F_{a,z}$ : 700 N
	D: 140 - 400 mm = $F_{a,z}$ : 720 N
	D: 450 - 630 mm = $F_{a,z}$ : 1.150 N
	D: 710 - 1.250 mm = $F_{a,z}$ : 1.150 N

## Find out how we can support you

Would you like to find out more about any of the solutions described in this brochure?

Or would you like to discuss how we could help you find the best possible solution for your project? Get in touch today!

### Singapore

South East Asia & Pacific

#### Walraven Pte. Ltd.

71 Lorong 23 Geylang #06-14  
388386 Singapore (SG)  
customerservice.sg@walraven.com

### Other countries

#### Walraven International

Industrieweg 5  
3641 RK Mijdrecht (NL)  
Tel. +31 297 23 30 00  
Fax +31 297 23 30 99  
export@walraven.com

### Walraven Group

Mijdrecht (NL) · Tienen (BE) · Bayreuth (DE) · Banbury (GB) · Malmö (SE) · Grenoble (FR) · Barcelona (ES) · Kraków (PL)  
Mladá Boleslav (CZ) · Moscow (RU) · Kyiv (UA) · Detroit (US) · Shanghai (CN) · Dubai (AE) · Budapest (HU) · Mumbai (IN)  
Singapore (SG) · Burlington (CA)